



**EMB-314 A-29 SUPER TUCANO 60TP
TURBO PROP**



An innovative original project to impress in the 60TP scale category!

High level of detail with amazing flight characteristics in docility and realism that draw attention on any airfield. The current EDA (Smoke Squadron) plane in 23.3% scale highly acrobatic as a model aircraft.



Assembly instructions manual and guideline**A-29 Super Tucano 60TP****Index**

Presentation.....	3
Important warnings.....	3
Disclaimer.....	5
Kit contents.....	5
Specifications.....	7
Fuselage junction.....	7
Kingtech K-60TP turbine installation.....	8
Cowling installation.....	12
Fuel tank installation.....	20
Servos, linkage, hard points and commands.....	24
Heavy duty double horn set.....	26
Important linkage warnings.....	26
Ailerons and flaps.....	27
Elevators.....	31
Rudder.....	34
Retracts installation.....	38
Electric retracts with eletromagnetic brakes.....	39
Landing gear doors installation.....	42
Main landing gear doors.....	43
Front landing gear door.....	45
C.G. (Center of Gravity)	47
LR Ideas scale lighting system.....	48
Scale lighting system and wing's clear parts installation.....	49
Fuselage on-board equipment.....	52
Fuselage side doors.....	54
Fuselage winglets gluing.....	56
Antennas gluing.....	56
Machine gun replicas installation (optional).....	58
Cockpit and canopy installation.....	59
Flábio Cockpits scale cockpit.....	60
Full body scale pilots in uniform.....	62
Programable robot pilots with arms and head movement.....	63
Pitot tubes replicas.....	73
Juniaer's transport and protection covers.....	73
Trophies and events.....	74



This is the A-29 Super Tucano 60TP ARF Juniaer, retracts installation ready, with flaps, with artistic finishing and several painting schemes available, very realistic and all detailed, with rivets, antennas, side door with hinge and lock installed, panel divisions, compartments, pitot tubes replicas, landing gear doors, cockpit with panels and clear canopy. Engine cowling in 2 parts with exhausts replicas. Made of high-quality epoxy resin with structural reinforcements, low weight and high resistance due to the FULL COMPOSITE high technology vacuum lamination technique. Carbon fiber tubes on wing and stabilizer. Laminated in fiberglass and epoxy resin with carbon fiber reinforcements with laser cut plywood and balsa structures. Clear canopy, resin canopy frame, resin cockpit with panels. Factory hinged ailerons, flaps and elevators in perfect alignment. Rudder to be installed with carbon fiber hinges and steel rod supplied with the kit. Tank tray in laser cut plywood. Artistic finishing made in automotive paint, vinyl, decals and varnished for great durability. Very stable, realistic and acrobatic flight pattern. Capable of many scale maneuvers such as rolls, slow rolls, Cuban eight, knife edge flight, inverted flight and more. This model was developed and built to provide high performance both in terms of flight and in terms of realism and details richness. It's construction is made with specific materials of high quality and advanced techniques of composite lamination to offer low weight and high structural strength.



The Juniaer model airplanes are painted and varnished with high quality and resistance products. Even so, some care must be taken to protect the paint: wipe your model with a cloth immediately after use with water sprays and neutral detergent. Fuels can damage the varnish if it penetrates punctures or damages to the plane's surface, as well as cuts in the engine's cowling. To prevent this kind of problem, we recommend brushing two-component PU varnish or applying epoxy to areas that are uncovered for any reason. Avoid exposing the model to direct sunlight as much as possible, especially the darker painted parts that accumulate and reflect a greater amount of heat, causing an internal and external temperature raising. The use of automotive wax for polishing is useful in preventing the accumulation of dirt and facilitates the cleaning and protection of the varnish. We suggest the use of fabric smooth covers for storage and transport, in order to protect against damage and risks. Be careful when handling your model airplane, especially the movable control surfaces. Never lift it by the two wing tips only, as the total weight is considerable to be supported only by 2 distant points. When checking the model airplane's balance through the center of gravity (C.G.) always support it by the roots of the wing at the indicated points.

Please read this manual to the end before doing anything on your model airplane, it contains important information regarding assembly and use, and it will also give you an overview of what should be done correctly and following the guidelines.

Please check and identify all parts of your model airplane when you receive it. If any parts are damaged or defective, please contact our customer service. Your model aircraft has a 90-day factory warranty against manufacturing defects. Juniaer Model Airplanes guarantees that this kit is free from manufacturing defects in both material and workmanship at the date of purchase. This warranty does not cover any components damaged by use or modifications. In no event will Juniaer's liability exceed the original cost of the kit purchased. In addition, Juniaer Model Airplanes reserves the right to change this warranty without prior notice. Since Juniaer Model Airplanes has no control over the final assembly or the equipment used for the final assembly, no liability will be assumed or accepted for any damages resulting from the user's use of the final product assembled by him or third parties. Through the act of using the assembled product by the user, he accepts all responsibility for the result. If the buyer is not prepared to accept responsibility for the use of this product, it must be returned immediately to the place of purchase in new and unused condition. This product is intended for persons over 18 years old and any procedure involved in its assembly and use must be monitored by an adult.

This is not a beginner's model aircraft, despite having a very stable flight performance and low speed stall point, it is a complex model with many mechanical and electronic devices and must be assembled and flown by someone with experience and knowledge in the area of model airplanes setup and flying. Never consider this

product as a toy. If in any case you do not feel 100% sure of what you are doing, if there are any unanswered questions or any other problem, please DO NOT PROCEED!!! Look for our guidance or any professional in the field. Any equipment badly installed, or problematic may cause the total or partial loss of the model, and serious consequences for people and properties around the flight area. If you want more information about insurance, legislation, rules and safety procedures, look for the Academy of Model Aeronautics www.modelaircraft.org Telephones Tel.: (765) 287-1256 / (800) 435-9262 Fax.: (765) 289-4248, which may indicate clubs with a structure that includes qualified flight instructors accredited to issue the operational license for model pilots that includes insurance. Also look for FAI – Fédération Aéronautique Internationale (World Airsports Federation) www.fai.org

Always check the operation of the model aircraft before all flights to ensure that the equipment is working perfectly and that the structure is intact. Always check all links, connectors and control surfaces and replace any component that shows signs of fatigue or wear.

VERY IMPORTANT: Juniaer Modelismo provides a high-quality kit with instructions, but the quality of the finished model depends on how it is assembled, therefore, the manufacturer and its dealers cannot under any circumstances guarantee the performance of the completed model. No complaints will be accepted regarding the performance and safety of the model aircraft after it has been assembled. “Juniaer”, “Juniaer Modelismo” and “Juniaer - Art in model airplanes”, as well as the logo, are registered trademarks of Juniaer industry, commerce, importation and exportation of model airplanes Ltda. All rights reserved.

Juniaer Model Airplanes

Telephone: +55 (35) 3591-1036

e-mail: juniaer@hotmail.com

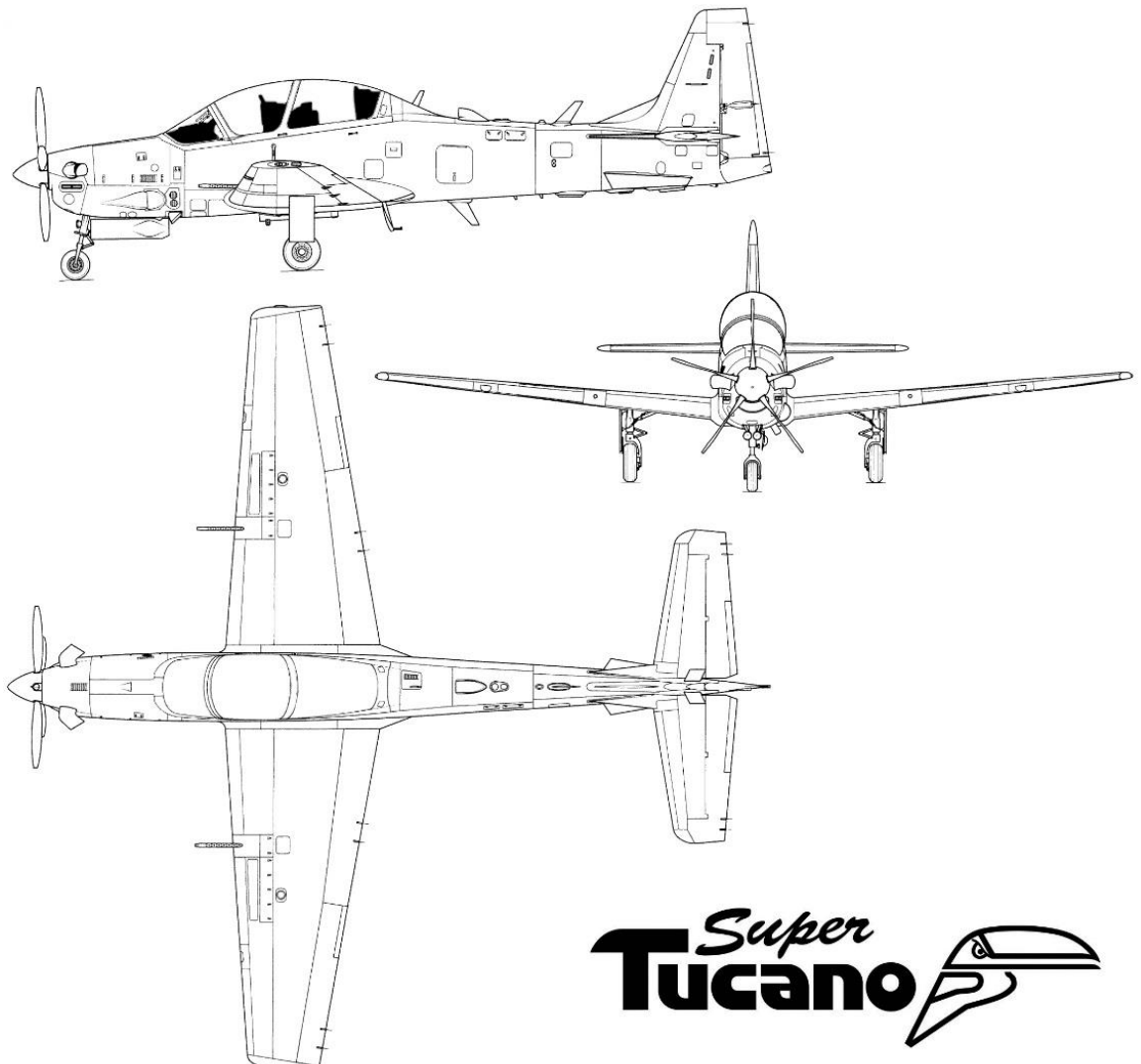

DISCLAIMER

In Brazil, model airplane activity for recreational purposes is regulated by ANAC (National Civil Aviation Agency) through the Special Brazilian Civil Aviation Regulation RBAC-E No. 94 that entered into force on July 1, 2021, or subsequent substitutive document.

Important information is contained in subparts **E94.3 Definitions; E94.103 General rules for the operation of unmanned aircraft; E94.301 Registration and cadastre and E94.501 General provisions.**

The Ministry of Defense, Aeronautics Command, Department of Air Space Control regulates the procedures and responsibilities necessary for access to Brazilian Air Space by unmanned aircraft with use exclusively for recreation, the so-called model aircraft through the **MCA 56-2** manual that entered into force on July 1, 2020, or subsequent substitutive document.

The radio control equipment used in model airplanes, according to the General Telecommunications Law (Law nº 9.472, of July 16, 1997) must be approved through a certification issued or accepted by ANATEL (National Telecommunications Agency). Information about this procedure can be obtained from the Certification and Numbering Management – ORCN ANATEL or by e-mail: certificacao@anatel.gov.br.

We recommend reading the documents cited for legal information about the operation of your model aircraft and the use of Brazilian airspace. For residents in other countries, we recommend researching local legislation, regulations and safety recommendations. Also look for FAI - World Airsports Federation www.fai.org.

All images, drawings and photos are for illustrative purposes only. Appearance and features of the product depend on how it is assembled or used by the user. All specifications, features and models described and shown are subject to change without notice.

Kit contents:

We recommend checking all items when you receive your model aircraft. Your A-29 Super Tucano 60TP Juniaer consists of the following items:

1 instruction manual containing disclaimer	1 front landing gear door
1 front fuselage	2 front landing gear door hinges
1 rear fuselage	2 canopy opening hinges
1 upper engine cowling	1 left wing
1 lower engine cowling	1 left-wing landing gear door
1 rudder	1 right wing
3 carbon fiber hinges for rudder	1 right-wing landing gear door
2 fuselage side doors	2 carbon fiber tubes 32mm diameter (wings)
4 fuselage side door hinges	1 set of clear lenses
2 spring latches for fuselage side door	2 pitot tubes replicas
1 simple cockpit	14 ¼" x ¾" allen screws for wing/fuselage attachment
1 canopy frame	14 washers ¼" for wing/fuselage/mount attachment
1 clear canopy	4 blind nuts 1/4"
1 left half stabilizer	1 carbon fiber turbine mount
1 right half stabilizer	2 rear fuselage winglets
1 carbon fiber tube 19mm diameter (stabilizer)	2 fuselage antennas
4 self-tapping screws 2.2 x 13 mm	2 fuselage antennas
1 2100cc fiberglass fuel tank with nozzle	1 small fuselage antenna
1 2700cc fiberglass fuel tank with nozzle	1 fiberglass ventilation nozzle for turbine



Specifications:

Wingspan: 2800 mm

Length: 2630 mm

Wing Area: 96,93 dm²

Wing Loading: 175 g/dm² to 185 g/dm²

Spinner: 4 3/4" (120 mm)

Turbines: Kingtech G-60TP

Weight: approx. 10 Kg Flying weight: 20 to 21 Kg (depends on installed accessories).

Radio: 9 channels minimum for limited installation. 12 or more channels for complete installation (not included).

Servos: 4 standard size servos (15kg-cm or more torque), 3 standard size servos 20 kg-cm or more torque and from 1 to 3 standard size servos (4 kg-cm 56,8oz-in or more torque). All servos must be metal geared.

Fuselage Junction

The fuselage is supplied in 2 sections that must be united together with 30 to 40 minutes epoxy glue and 6 screws with washers to get permanently glued or can be used for assembly/disassembly for transport.

To assembly and disassembly the 2 fuselage sections tighten or loosen the 6 screws with washers on the 1/4" blind nuts already installed in the rear fuselage section. Apply medium grade thread lock to the screws and tighten well until locked in place. If you prefer to glue the 2 fuselage section definitively test the union of the 2 parts and check the perfect fit between them. Sand the parts to be glued with 120 to 150 grit sandpaper to increase the adhesion of the glue. Apply epoxy glue to the front section of the fuselage across the area to be glued, then join the parts together. Apply high grade (permanent) threadlocker to the threads of the 6 1/4" x 3/4" allen screws (supplied with the kit) and insert them with the 6 1/4" washers through the front section of the fuselage tightening until are very firm, thus achieving perfect alignment of the fuselage. Remove excessive glue with a cloth soaked in alcohol and wait for the glue to cure completely.



Above: application of epoxy glue on the front section of the fuselage (left), parts joined with screws and washers in the final location (center) and 1/4" x 3/4" allen screw with 1/4" washer to be used (right).



Above: the 2 fuselage sections joined after gluing and tightening the screws.

Kingtech K-60TP turbine installation



Before installing your gasoline engine, please carefully read the manufacturer's manual and all parts assembly recommendations including exhaust, mounts, ignition, installation, operation and maintenance. The information contained in this manual is extremely important.

The model airplane's firewall is provided in correct place, with correct angles for turbine installation and with markings for the 4 carbon fiber mount holes. Drill in the 4 marked positions with a drill and 5mm drill bit. Position the 4 screws 5x20mm with the washers 5mm inside the firewall. Apply a medium degree threadlocker (removable) to the screw threads and screw the carbon fiber turbine mount in front of the firewall, ensuring that a solid, firm fixation is obtained with 90 degree alignment with the firewall. Position the turbine on the mount to obtain the turbine's 4 horizontal fixing holes and 3 vertical fixing holes location.

IMPORTANT: The original metal tube for lubricating the gearbox, when installed, is too high in relation to the carbon fiber turbine mount, being necessary to adapt it to allow the later installation of the upper cowling.

It is recommended to apply water-based thermal protection paint containing ceramic microspheres to prevent overheating of the turbine mount and cowling.

All fuel hoses and turbine cables must under no circumstances come into contact with parts of the turbine block that are very hot during and after operation.



Above: 3 thermal protection paint layers applied on the carbon fiber turbine mount.

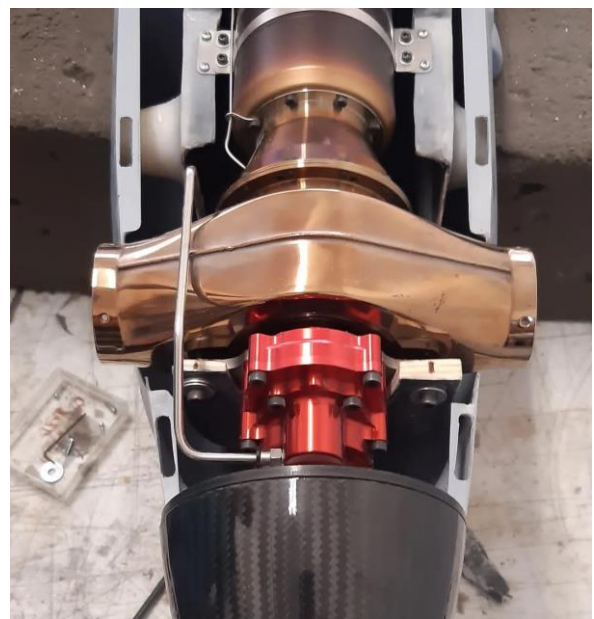

Above: turbine position on the carbon fiber turbine mount and lubrication tube position.



Above: turbine position on the carbon fiber turbine mount and lubrication tube position.

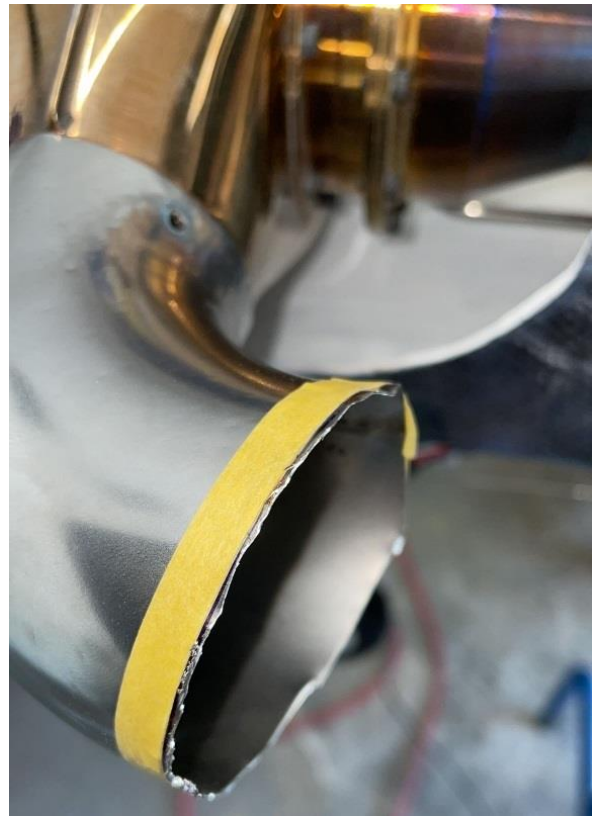

Above: exhausts cutting for realistic and scale appearance.

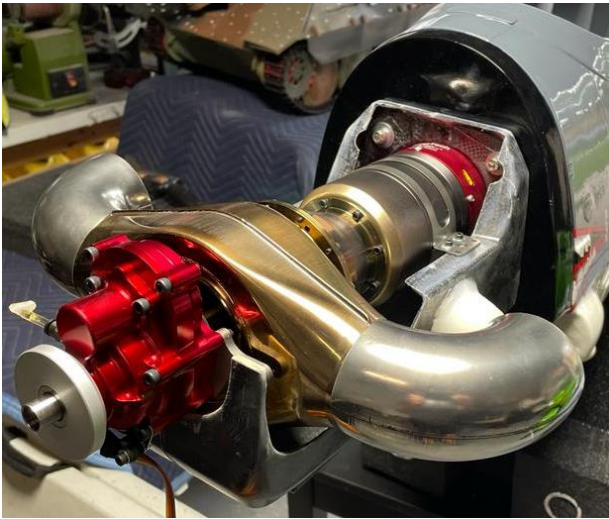

Above: exhausts position installed on turbine.



Above: cut exhausts position on turbine for realistic and scale appearance.

Very important: all fuel hoses and turbine cables must not, under any circumstances, come into contact with parts of the turbine block that are very hot during and after operation. For this, we recommend fixing them to the mount with nylon clamps firmly and without the possibility of moving.

The most suitable turbine exhaust outlets according to the scale of the model aircraft are 55mm in diameter, 0.2mm thick, with 90 degrees of deflection and 100 radius of curvature. We recommend those made of stainless steel by Zimmermman Schalldämpfer code #5060. We recommend water-based thermal protection paint with ceramic microspheres manufactured by BVM Jets code PA-MA-1940 (down-left).

We recommend the instalation of o FOD screen to protect the air intake to avoid solid particles absorbing by the turbine (below a direita).



If you want to install a smoke pump, it is necessary to install the smoke fluid tube in the turbine gas outlet with Dubro connections (DUBR 192) as shown in the photos below:



Above: Dubro DUBR 192 connections (left) and hole for installing the connections for smoke fluid in the turbine exhaust body (right).

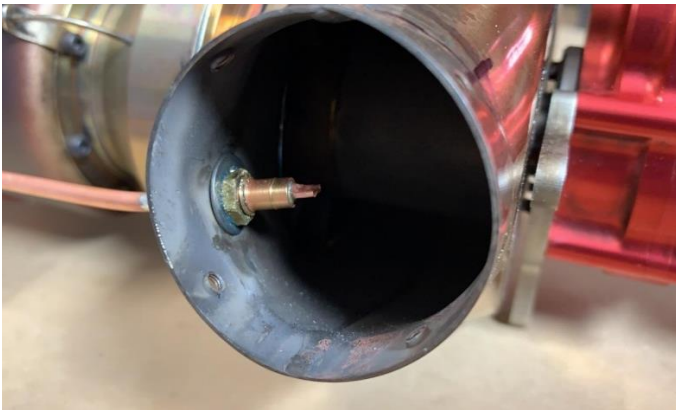

Above: fittings installed showing the flattening at the end of the tube for better spraying of the fluid (left) and final position with complete installation (right).

Instalação da carenagem do motor



It is necessary to cut the two parts of the nose cowling to allow the passage of the turbine's exhausts, so that there is no direct contact between the parts due to the high operating temperatures. The carbon turbine mount provided for the K-60TP version has 2 side cowling fixing brackets to ensure better support and fixation.

The engine cowling is provided in 2 parts (upper and lower). The parts have perfect fittings among themselves and in the fuselage, providing the correct alignment according to the center between the fixing holes of the turbine mount and the firewall angles. Using the back plate of the spinner (4 3/4") positioned on the prop washer of the turbine, position the lower part of the engine cowling in such a way as to center the spinner back plate with the circumference formed by the cowling, leaving spacing of 1 to 2mm between the spinner back plate and the cowling so that they do not touch in any position.

To fix the cowling to the fuselage, apply epoxy glue to 4 10mm hardwood cubes and glue them to the inside of the fuselage, in order to make a solid fixing point where the fixing screws will be inserted. Do the same at the fixing points at the bottom of the cowling or use screws with self-locking nuts to ensure fastening even with high levels of vibration. With the correct alignment of the set, permanently screw the cowling parts together and to the fuselage using washers to increase the contact area with the cowling parts avoiding damage and cracks due to vibration. The screws to be inserted in the wooden cubes must be locked with a drop of medium CA glue or epoxy to reinforce the lock and ensure greater resistance. The horizontal and vertical inclination of the spinner backplate and the front part of the cowling must be equal, parallel and centralized.

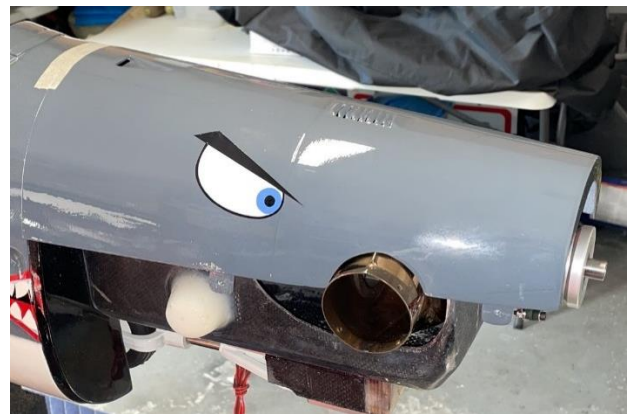

Above: upper cowling alignment with propwasher and exhausts holes.



Above: upper cowling alignment with propwasher and exhausts holes.

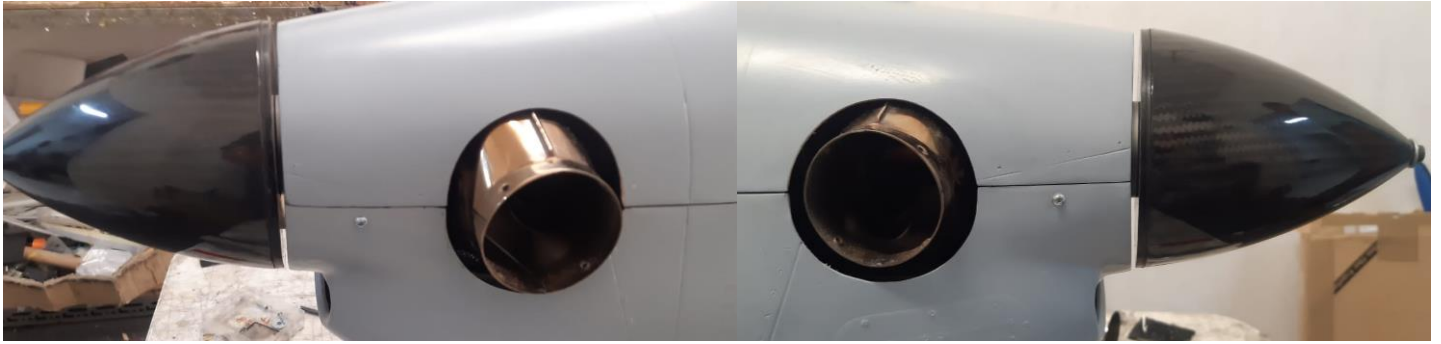

Above: correct alignment of the nose cowling with the spinner assembly and turbine exhausts holes.

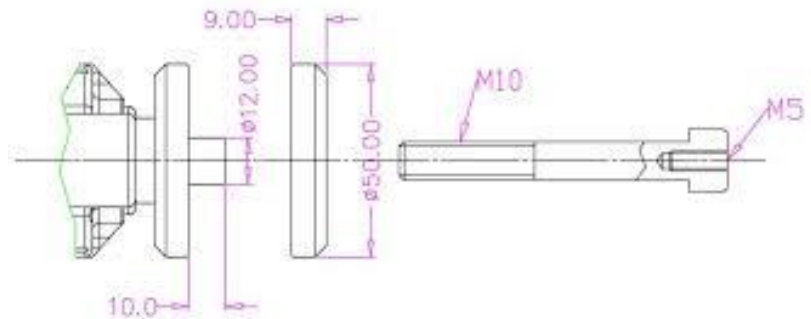

Above: cowling and spinner correct alignment (left) and spinner fixing screw dimensions (right).

Another cowling attachment option is to use studs bolts to attach the upper and lower part of the cowling to the fuselage, which have internal and external threads. To do this, make holes on the sides of the fuselage in the firewall to insert the screws through the cowling and in the front to insert epoxy glue and lock the screws definitively as shown in the photos below.

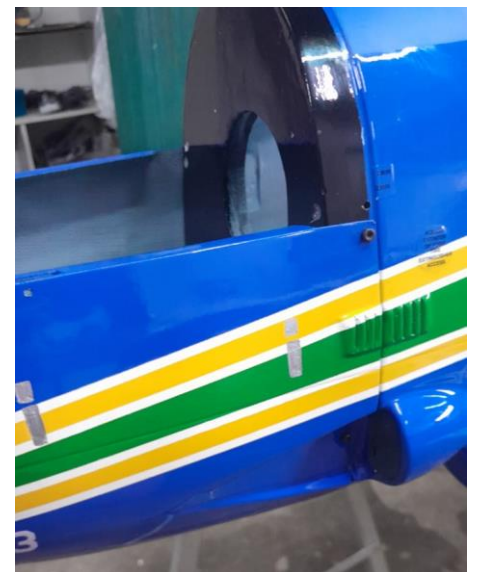

Above: markings of the 4 holes for fixing the turbine mount in the central part of the firewall and 9 holes for fixing the cowling with stud bolts at the ends of the firewall (left and center) and lower fairing attached to the fuselage (right).



Above: lower cowling screwed to the fuselage in the correct alignment (left and center) and the 2 cowling parts already with holes for exhausts in the correct alignment (right).



Above: position of the turbine mount on the firewall with lower cowling (left) and the turbine with exhausts fixed to the turbine mount and the firewall with lower cowling (right).



Above: alignment of the 2 parts of the cowling with the spinner and holes for the exhaust pipes.

To join the upper and lower cowling, 4 self-tapping nuts (blind nuts) 10-32 (DUBR 584) can be used glued to the upper cowling with epoxy to ensure excellent fixation and 4 screws 10-32 x 1/2" (DUBR 579) . Not supplied with the kit.



Above: upper cowling with 4 blind nuts 10-32 glued with epoxy and painted with water-based thermal protection paint with ceramic microspheres.

IMPORTANT: It is recommended to apply water-based thermal protection paint with ceramic microspheres to prevent overheating of the nose cowling and turbine mount, especially the upper cowling. 3 coats of paint applied by brush with 30 minutes between each coat are required for adequate protection. A layer of thermal insulating fabric based on ceramic fiber and a layer of aluminum foil can also be added on the outside with the shiny part facing the turbine for greater thermal protection of the upper cowling, which is exposed to higher temperatures for longer periods.

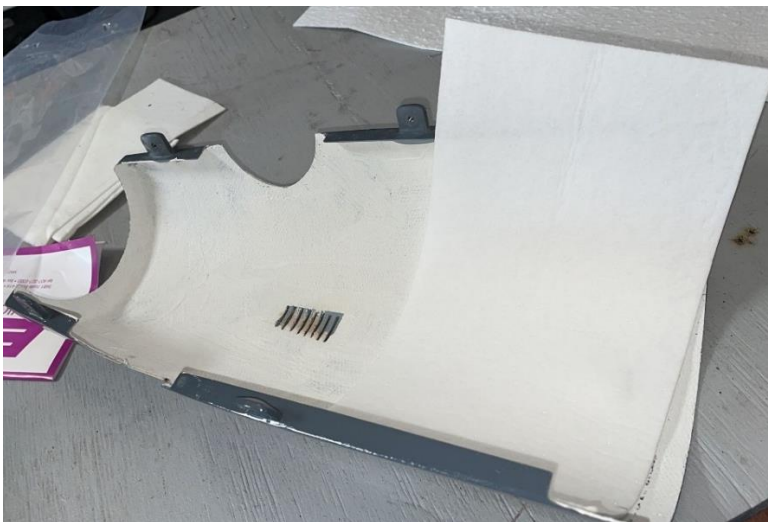

Above: inner part of the upper cowling painted with thermal protection paint and application of a ceramic fiber fabric (left) and a layer of aluminum foil on the outside (right).

The kit includes a cooling nozzle made of fiberglass to channel part of the air flow that enters through the lower cowling nozzle towards the turbine reduction gear box for cooling, in order to lower the operational temperature and increase the lifespan of the turbine gears.



Above: ventilation nozzle to channel part of the air flow to the turbine's gearbox in 3 views.

This part must be glued with 30 to 40 minutes epoxy glue on the lower cowling positioned as shown in the photos below, at an angle so that it does not touch the turbine mount. If necessary, make adjustments to the part until it can be inserted without coming into contact with the turbine mount. It is necessary to cut off the rear part to allow some of the airflow to go directly into the cowling through the vent hole.



Above: position of gluing the ventilation nozzle to the lower cowling and the cutout at the rear of the nozzle to allow the passage of part of the air flow directly to the rear.



Above: : position of gluing the ventilation nozzle to the lower cowling.

We offer custom-made wooden propellers for the A-29 Super Tucano 60TP Juniaer (sold separately). Always consult the engine instruction manual to decide on the size and pitch of a propeller and consider the desired performance according to the characteristics of your model airplane. 2 blade propellers are ideal for engine break-in and flight tests, as they provide higher RPM and greater speed of response to engine acceleration, while 3 blade propellers and 5 blade propellers provide lower RPM, being very suitable for scale models, however, they present a lower speed of response to engine acceleration.



Above: 5-blade 24x23,5 propeller.



Above: spinner cut sequence to install the 5-blade propeller using equal shape adhesives.



Above: spinner cut sequence to install the 5-blade propeller using equal shape adhesives (left) and spinner balancing to guarantee minimum vibration level to the spinner/propeller set (right).



Above: spinner/propeller set ready and balanced.
IMPORTANT: the spinner parts shall never touch the propeller.

Fuel tanks installation

Your T-27 Tucano 60TP model aircraft includes 2 tanks with 1900ml capacity each made of fiberglass and epoxy resin with aluminum tube to install the connections. To install the fuel tanks, first assemble the tank connections (not included) according to the manufacturer's instructions, making sure they are leak-free and with the clunk free in all possible positions. Only 2 connections are needed on the tank: clunk with fuel outlet and air vent/excess fuel drain.

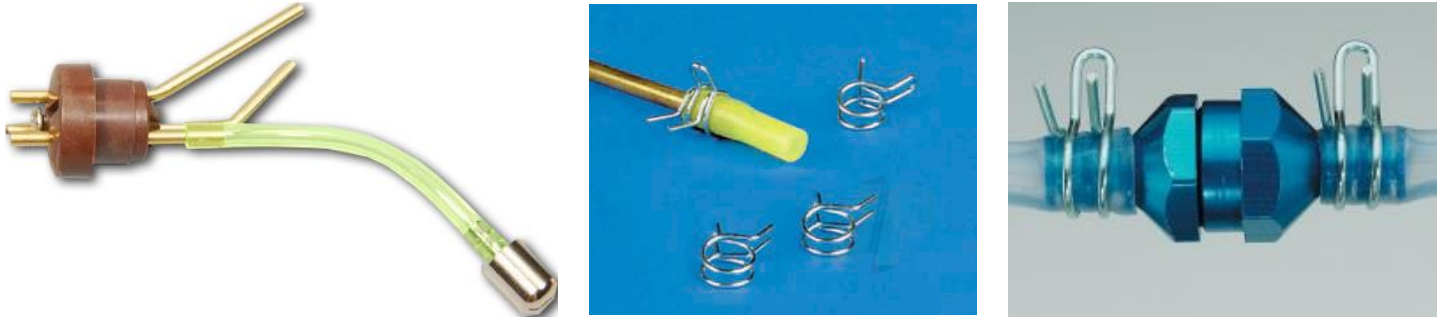

Above: Dubro fittings with internal fuel tank connections (left), safety clips for the connections (center) and fuel filter with safety clips on the connections (right).

Use DUBRO DUB 400 rubber gasket. For fuel tank connections we recommend 5/32" (4mm) diameter tygon hoses and safety clips (DUB 678).

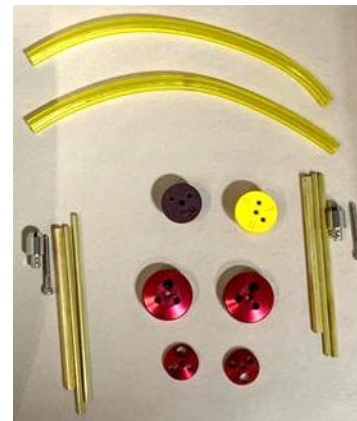

Above: the 2 tanks that come with the model aircraft and example of simple connections used in the center (not included).

In the case of turbine power supply, there are professional and elaborate fuel connections, which include a fuel hose locking system through threaded nuts, a clunk extender to avoid bending the clunk's hose and are quite suitable for safer and high-performance installations like this example:



Above: clunk mounted without extender (above) and with clunk extender (below) to prevent hose bending (left) and complete connections including air vent manufactured by Rio Jets – sold separately (right).

The set includes: 1 tank nozzle (installed), 1 air vent connection with hose lock (installed on tank), 1 clunk with hose lock, 1 clunk extender with 2 hose locks and 1 tank cover with sealing o-ring and 2 hose locks.

The clunk's set must be 16,5cm long from the bottom of the cover.

When inserting the hoses in the connections, screw the hose locks until they are snug, and when inserting the clunk assembly into the tank, tighten the cap by screwing it firmly until it is fully inserted into the tank nozzle with the sealing o-ring all inside, ensuring perfect sealing of the tank.



Above: total length of clunk assembly 16,5cm.



Above: fuel tank with Rio Jets nozzle and air vent installed and internal connections with cover.



Above: fuel tank with Rio Jets nozzle and air vent installed and clunk assembly with extender and cover (left) and fully assembled fuel tank ready for installation on model airplane (right).



Above: example of UAT to be used between the fuel tank and the turbine fuel pump (left), Kingtech UAT (center) and JP Hobby UAT (right).

The UAT must be positioned inclined at 45° to eliminate air bubbles from the fuel line and one of its upper connections is intended to supply the tank(s) through a hose with a plug.

Use a kerosene compatible fuel filter. The fuel filter must be positioned between the turbine fuel pump outlet and the turbine fuel inlet.

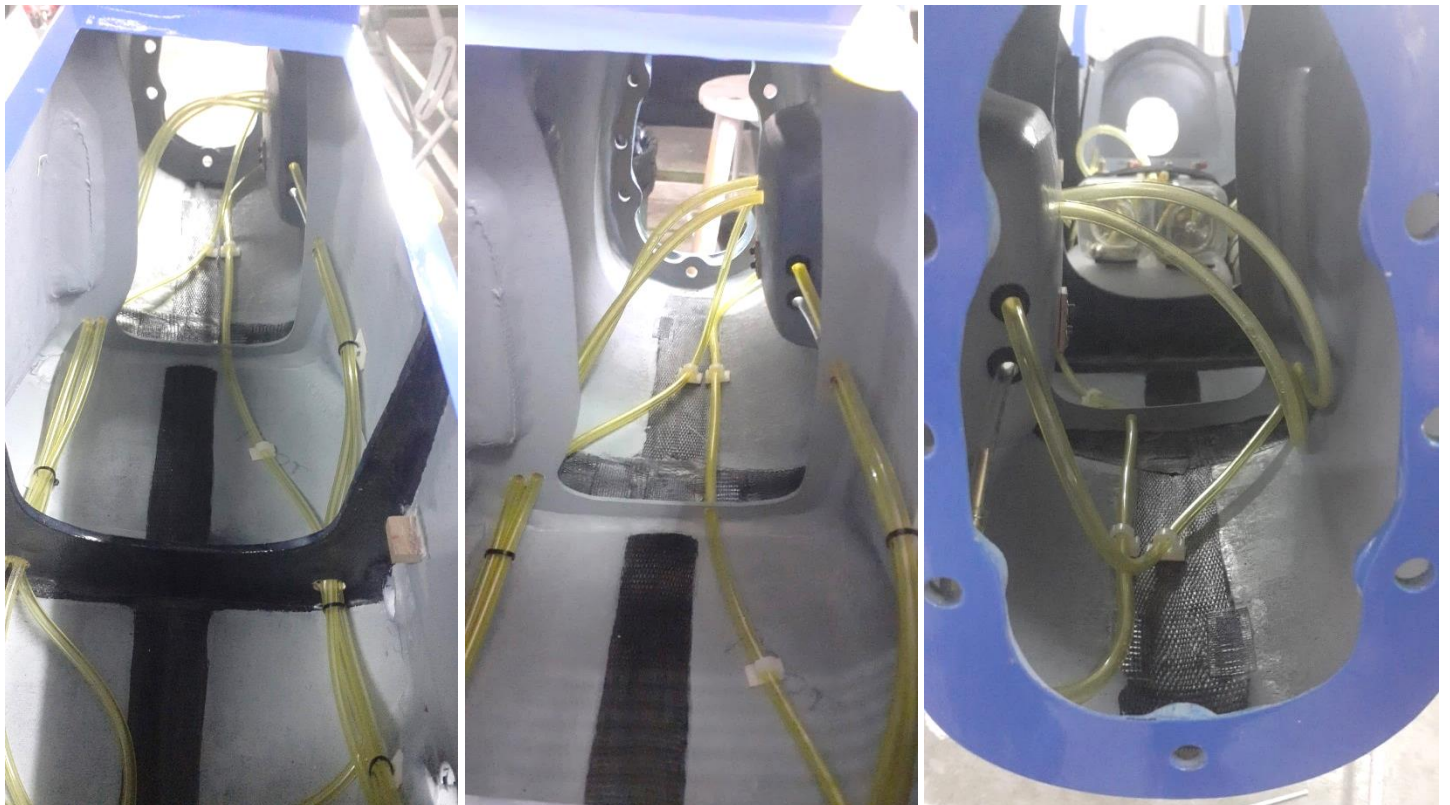

Above: installation of the fuel hoses in the fuselage with connections in the side door of the fuselage seen from the front of the fuselage (left and center) and from the rear of the fuselage (right).

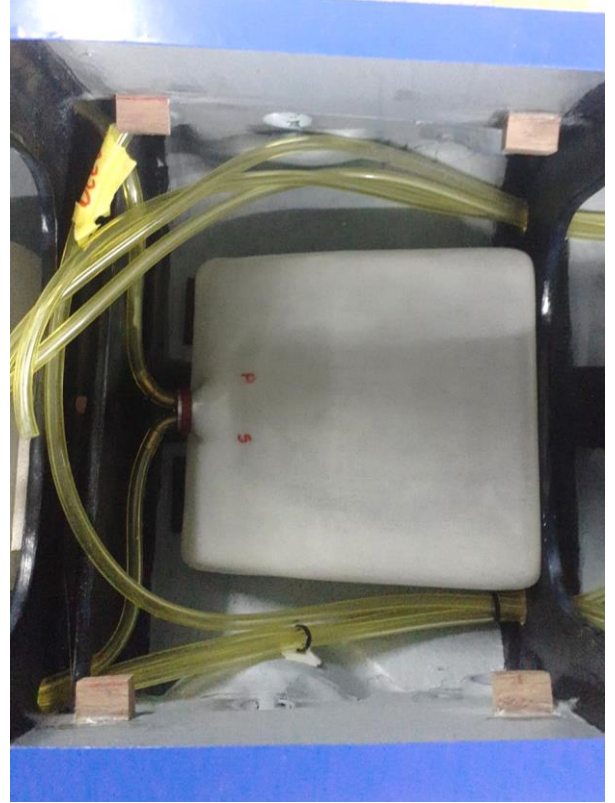

Above: installation of the fuel hoses in the fuselage with connections in the side door of the fuselage (left) and rear tank position on the bottom of the fuselage (right).

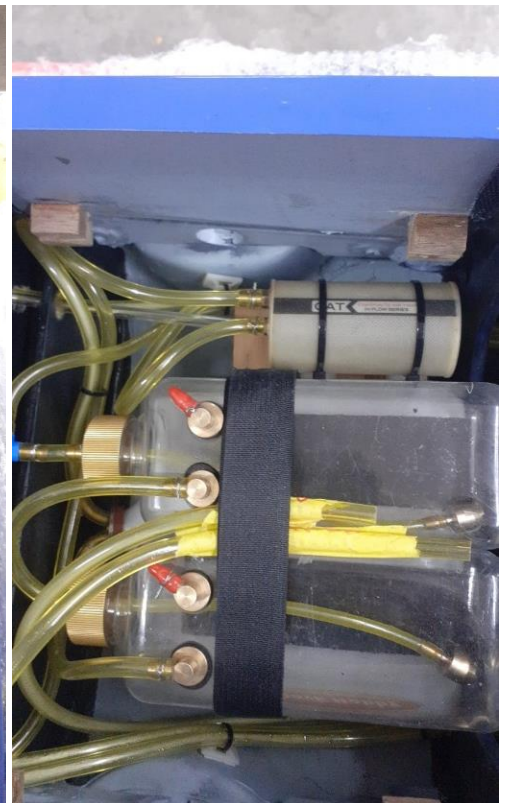

Above: 2 500ml smoke fluid tanks installation above the rear fuel tank (left) and UAT on right also above the rear fuel tank (center and right).

Servos, linkage, hard points and commands

All servos must be metal geared (not included).

4 standard size servos 15 Kg-cm or more torque to the flight surfaces are necessary: 2 for ailerons and 2 for elevators. Suggestions: Savox SC0251MG, Futaba BLS155, Futaba BLS351, JR DS8717HV, JR DS2917HV.

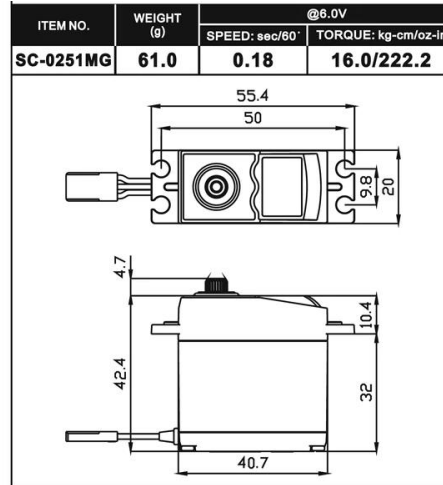

Above: Savox SC0251MG servo and specifications according to the manufacturer.



Above: Futaba BLS155 servo (left) and JR 8717HV (right).

4 standard size servos 20 Kg-cm or more torque to the flight surfaces are necessary: 2 for flaps, 1 for rudder and 1 for front landing gear door. Suggestions: Savox SA1256TG, Futaba BLS156HV, Futaba BLS175SV, Futaba BLS175HV, JR DS8611A.

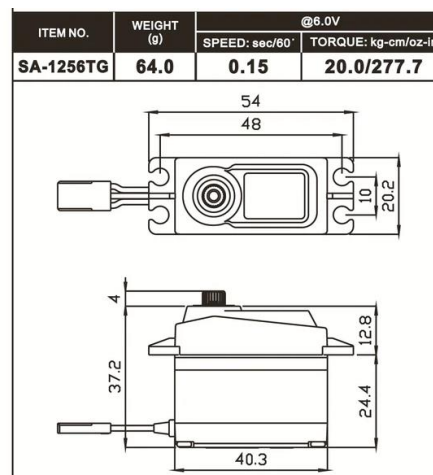

Above: Savox SC1256TG servo and specifications according to the manufacturer.



Above: Futaba BLS156HV (left), Futaba BLS175SV (center) and JR DS8611A (right).

If using pneumatic retracts it is necessary 1 more standard size servo with 4Kg-cm (56,8oz-in) or more torque for air valve command. Suggestions: SAVOX: SAVSC0254MG, SAVSC0253MG, SAVSC0252MG

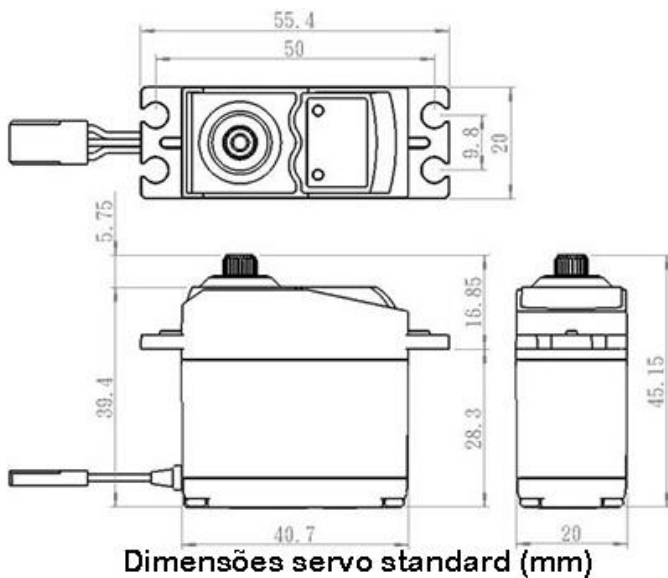

Dimensões servo standard (mm)



Above: standard size servos dimensions (left) and Savox SC0252MG (right).

For front wheel steering 1 standard size servos 8,9kg-cm or more torque is necessary. Suggestions: Futaba S-3305, Savox SAVSC0252MG.

The model airplane has structural reinforcements of high rigidity for installation of the ailerons, flaps, elevators and rudder controls control horns. These points measure 5cm x 5cm, are positioned in strategic locations and must be identified according to the instructions below. If you want to modify or adapt equipment that requires modifications to the original design, never do this on your own. Please contact Juniaer through our service channels to check on the possibility of installation.

All horns must be heavy duty and suitable for ¼ scale model aircraft or for giant scale model aircraft. All servo arms must be heavy duty and suitable for ¼ scale model aircraft or giant scale model aircraft. All rods must be steel, with thread and diameter 4-40 or greater. All servo links and connectors must be heavy duty and suitable for ¼ scale model aircraft or for giant scale model aircraft.

Fiberglass double horn set (Heavy Duty)

We offer (sold separately) the sets of custom fiberglass horns for the A-29 Super Tucano 60TP Juniaer, in heavy duty version (double horns), machined CNC cut.

Includes: 10 standard horns (4 ailerons, 4 elevators and 2 or 4 for rudder) and 4 straight horns for flaps for external installation.

To install it is necessary to make a slot with a sharp knife or drill with a 1mm drill so that the horns are inserted inside the rigid points of reinforcement up to their bases. After obtaining the correct fit, apply 30 to 40 minutes epoxy glue for permanent fixation. The connection point of the horns with the links must be centered with the hinge line of the control surfaces.

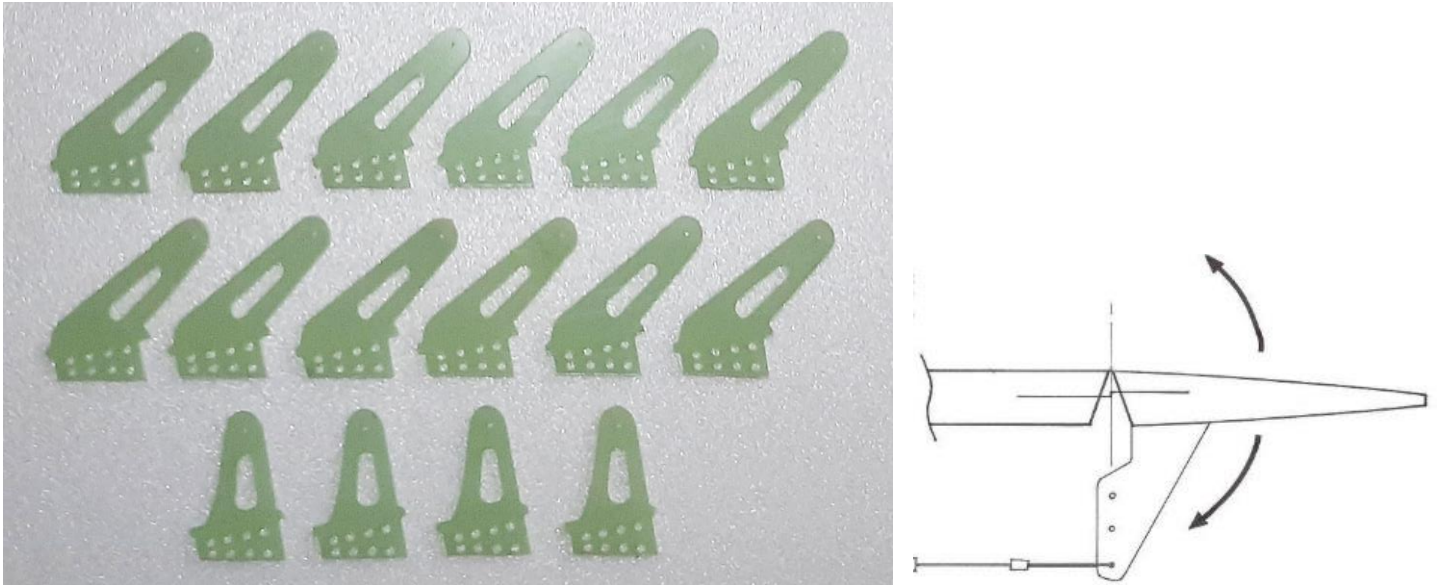

Above: heavy duty fiberglass control horn set, including 8 straight horns and 8 standard horns (left) and horn slots alignment with hinge line of the command surface (right).



IMPORTANT WARNINGS

WE DO NOT RECOMMEND INTERNAL LINKAGE INSTALLATION BECAUSE IT DAMAGES IMPORTANT STRUCTURAL PARTS THAT MAY RESULT IN ACCIDENTS AND TOTAL OR PARTIAL LOSS OF THE MODEL AIRPLANE, OFFERING RISKS TO PEOPLE AND PROPERTIES AROUND THE FLYING AREA. THE WING TRAILING EDGES AT THE AILERONS AND FLAPS AND THE STABILIZER TRAILING EDGE ON ELEVATORS MAY NOT BE DRILLED, CUTTED OR PERFORATED UNDER NO CIRCUMSTANCES.



Above: gray areas (trailing edges) on stabilizer shall not be drilled or cut.



Above: gray areas (trailing edges) on ailerons and flaps shall not be drilled or cut.

Ailerons: 4 standard horns with a height between 30mm to 40mm are required. The servo arms (length between 40mm to 45mm from the center to the end) must be positioned to the side of the wing root. Note that the two sides of the wing have the same position. The horn reinforcement is centered with the line formed by the slot where the servo arm is exposed. Distance between the center of the control arm and the hole of the horn (in neutral position): 115mm. The servos must be screwed directly to the ribs inside the wing, which are previously drilled. Before definitively screwing the servos, apply a drop of medium CA glue or epoxy glue to each hole. It is necessary to open a slot in the servo compartment cover to pass the servo arms as shown in the photos. To fix the servo compartment cover, apply a drop of medium CA glue or 5-minute epoxy glue in each hole for better fixation and resistance to vibration. Recommended deflection: Between 18mm (low rate) to 25mm (high rate) – up and down. To measure the deflection, place a ruler at the end of the control surface and move it.

Flaps: 4 straight horns with height between 25mm to 35mm are required. The servo arms (length between 40mm to 45mm from the center to the end) must be positioned to the side of the wing root on one side and to the wing tip on the other side, as well as shipped from the factory. The horn reinforcement is centered with the line formed by the frieze where the servo arm is exposed. Distance between the center of the control arm and the hole of the horn (in neutral position): 115mm. The servos must be screwed directly into the ribs inside the wing, which are previously drilled. Before definitively screwing the servos, apply a drop of medium or epoxy CA glue to each hole. It is necessary to open a frieze in the lids of the servo boxes to pass the servo arms as shown in the photos. To fix the servo box lids, apply a drop of medium CA glue or 5 minutes epoxy glue in each hole for better fixation and resistance to vibration. Recommended deflection: Between 15mm for takeoff and 60mm for landing. To measure deflection, place a protractor on the leading edge of the flap and move it.

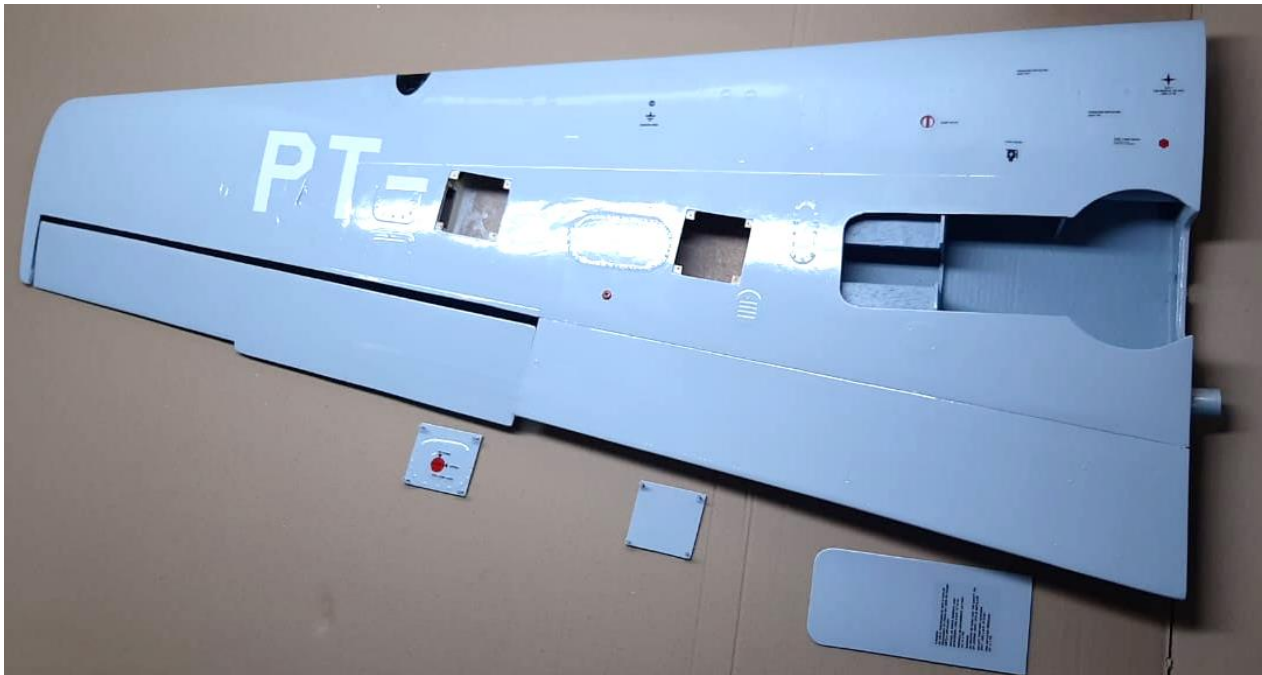

Above: servo compartment access covers location for ailerons and flaps servos and fixation holes on ribs.

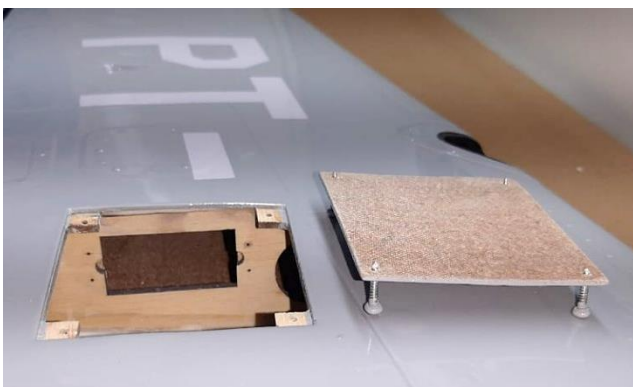

Above: servos fixation bases location on wing's ribs. Aileron (left) and flap (right).

To pass the servo extensions inside the wing, position it with the tip upwards and insert a thread with a weight tied at the end through the aileron servo box, passing through the hole in the wing spar to the leading edge until exit through the front hole of the wing root. Connect the extensions to the servos (aileron and flap) and lock the connectors so that they do not come loose in any situation. Tie the end of the aileron servo extension to the end of the thread in the aileron servo box and carefully pull the connector to the wing root. Attach the outer tip of the extension to the root of the wing with adhesive tape. Repeat the same process for the flap servo extension. Repeat the same process for the other half of the wing.



Above: thread and extensions passing process on wing with the servos.

Before definitively screwing the servos, apply a drop of medium CA glue or 5 minutes epoxy glue to each hole in the ribs where they will be fixed. To screw the flap and aileron servos onto the internal ribs of the wing, use a short screwdriver to keep the screw angle at 90° in relation to the ribs, as there is little internal space. It is necessary to open a slot on the servo compartment covers to pass the servo arms as shown in the photos. To fix the servo compartment covers, apply a drop of medium CA glue or 5 minutes epoxy glue in each hole for better fixation and resistance to vibration.



Above: short screwdriver and correct position to screw the wing's servos.



Above: aileron and flaps horns gluing process. Open slots (left), horns position with installed LED linkage (center) and glued horns on aileron command surface (right).



Above: location of the 40mm x 40mm reinforcements for fixing the horns on the right wing.



Above: location of the 40mm x 40mm reinforcements for fixing the horns on the right wing (left photo) and positioned and glued horns on the left wing (right photo).



Above: horns positioned and glued to the left wing (note that the flap horns are straight and the aileron horns curved).

To assemble the two wing halves in the fuselage, **2 32mm external diameter x 3mm thickness x 532mm long carbon fiber tubes** are used. The wing / fuselage set is pre-adjusted at the factory and uses 4 allen screws 1/4 "x 3/4" and 4 washers 1/4" (supplied with the kit), 2 screws with washers on each side. Insert the tubes into the fuselage until centered. The wing halves has 3 holes in the root, the front hole to allow passage for ailerons and flaps servo extensions and lights into the fuselage, the central hole where the tube must be inserted and the rear hole for servos and retracts extensions. At the rear there is a pin made of 1" diameter aluminum tube to align the wing halves at their correct angle of incidence (+2 degrees). The drawing below shows the position of the 3 holes and pin. Insert the halves, check that the roots of the wing are perfectly aligned with the shape of the wing in the fuselage. Insert the screws with washers into the holes in the lower part of the wing halves in the holes identified below by the letters X and tighten them until they are tight. We recommend the use of a medium-grade (removable) thread lock.

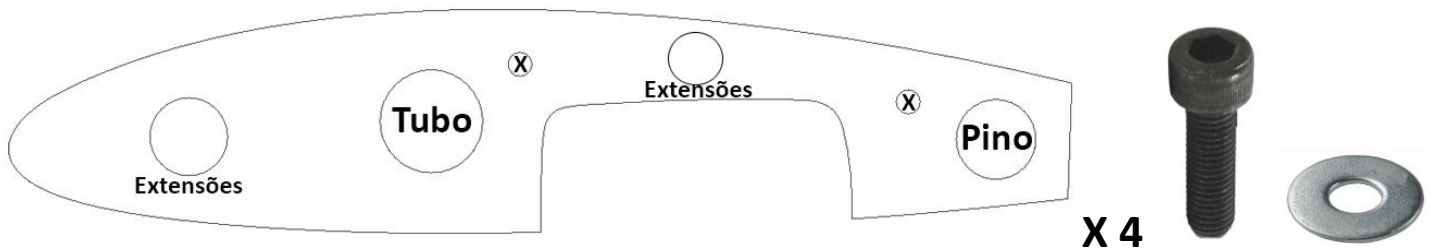

IMPORTANT: THE WING FIXING SCREWS MUST BE INSERTED OUT OF THE FUSELAGE TO THE INSIDE AND NEVER FROM INSIDE TO OUTSIDE.

Elevators: 4 simple horns needed, 30mm to 40mm tall. Servo arms 40mm to 45mm from center to the end. Horn reinforcements measure 50mm x 50mm. The servos must be screwed directly into the ribs inside the stabilizer according to photos, which are previously drilled. Before definitively screwing the servos, apply a drop of medium CA glue or 5 minutes epoxy glue to each hole. It is necessary to open a slot in the roots of the stabilizer for the passage of the servo arms as shown in the photos. To fix the servo compartment covers apply a drop of medium CA glue or 5 minutes epoxy glue in each hole for better fixation and resistance to vibration. Recommended deflection: Between 27mm (low rate) to 35mm (high rate) - up and down. To measure the deflection, place a ruler at the end of the control surface and move it.

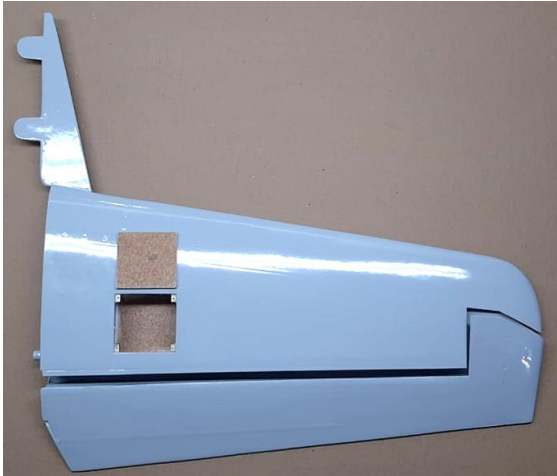

Above: elevator servo compartment access cover location (left) and servo fixation rib (right).

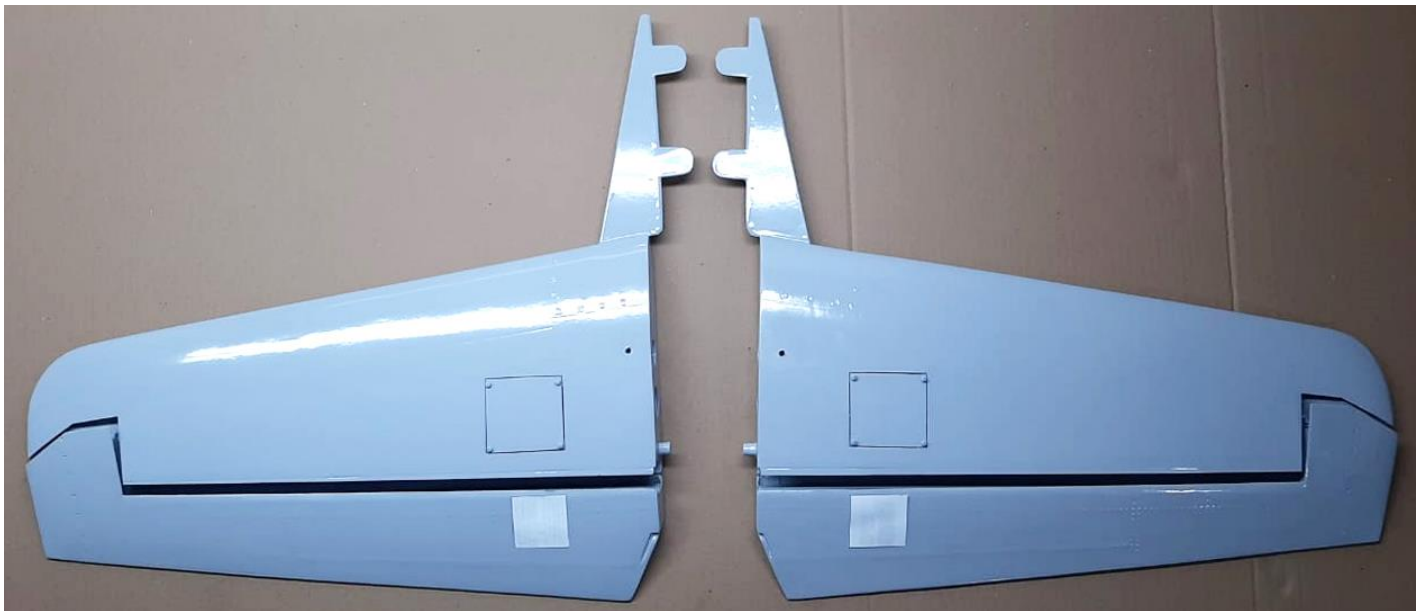

Above: elevator servos compartment covers location and horns hard points location.



Above: elevators servos, servo arms and horns position with linkage.



Above: elevators servos, servo arms and horns position with linkage.

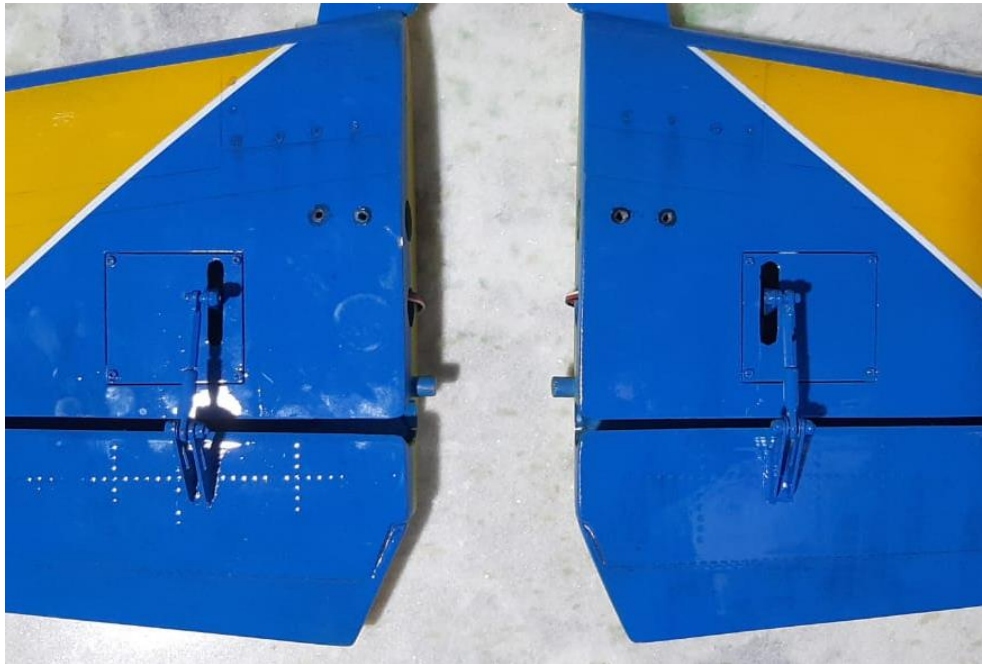

Above: servos position, servo arms, horns and elevators commands with Dubro 4-40 Heavy Duty ball links fixed on horns with 4-40 screws and parlock nuts.

IMPORTANT: even using parlock nuts it is necessary to apply thread locker on the screws.

To assemble the two halves of the stabilizer in the fuselage, an **carbon fiber tube with an external diameter of 19.05mm (3/4") x 1mm thickness x 570mm length** is used. The stabilizer assembly is pre-adjusted at the factory and the carbon fiber tube must be drilled on both sides for fixation and removal with 2 self-attacking screws 2.2mm x 13mm (supplied with the kit). Insert the tube into the fuselage until it is centered, aligning the holes vertically. The stabilizer halves roots have 2 holes, the front through which the tube should be inserted and the rear, to allow passage of the elevator's servo extensions into the fuselage. At the rear there is a hardwood pin to align the stabilizer halves at their correct angle of incidence (0 degrees). The drawing below shows the position of the 2 holes and pin. Insert the stabilizer halves. Check that the roots of the stabilizer are perfectly aligned with the shape of the stabilizer in the fuselage. If necessary, adjust the pin to ensure that perfect horizontal alignment and tight fit in the fuselage. At the front of the stabilizer's fins on both sides there are 2 guides that must be inserted in the slots already made at the factory in the fuselage. The 2 guides guarantee the correct horizontal alignment of the fins and do not require gluing or fixing.

With the stabilizer halves fully inserted and in the correct position, drill a hole with a drill and 2mm drill bit at the bottom of the stabilizer halves, where there is a circle that reproduces an aircraft inspection cover. Insert the screws and tighten them until they are firm. We recommend using a medium-grade (removable) thread lock.

Another option for assembling the stabilizer is to glue the 19mm carbon tube with 30 to 40 minutes epoxy glue to one half of the stabilizer and fix it with 2 screws only on the other side, but in this way the carbon tube can no longer be removed of the stabilizer half where it was glued.

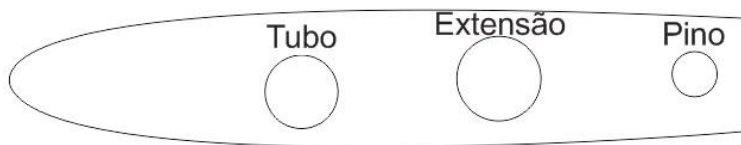

X 4



Above: position of the tube in the middle of the stabilizer and fuselage (left) and detail of the holes location for fixing the stabilizer halves in the stabilizer tube (right).

Rudder: To assemble the rudder, 3 3D printed carbon hinges are required (supplied with the kit). Rudder hinges are shipped separately. First install them on the rudder by gluing them with 30 to 40 minutes epoxy glue, filling the holes with glue and inserting them until the end of the housings. Wait for full cure.

Then position the rudder in the vertical stabilizer by inserting the hinges in their housings and adjust the position in order to allow total deflection of the command. To glue the vertical stabilizer hinges, apply 30 to 40 minutes epoxy glue and insert them in the correct alignment, fixing with adhesive tape until the glue cures completely. Remove any excessive glue with a cloth moistened with alcohol. Make sure that no glue is left in the center of the hinges (mobile part). Note the alignment between the rudder and the vertical stabilizer so that they are as close as possible, however it is not necessary to fully insert the hinges into the drift to maintain full rudder deflection movement to the right and left.



Above: 3 carbon fiber hinge set provided with the kit.



Above: rudder hinges housings.



Above: rudder with glued hinges (left), housing for hinges on the vertical stabilizer (center) and rudder glued and installed (right).

There are 2 rudder linkage options:

Right side horns with servo on tail.

Main features: agile command with simple and fast installation. Weight aggregation in the tail that can influence the balance of CG with the addition of extra weight in the nose. 2 simple control horns with total length between 30mm to 35mm required. The servo arm must be simple (with 1 side drive) with a total length between 35mm to 40mm. The horn holes are centered with the height of the servo arm installed on the original servo tray. Servo installed inside the fuselage on the tail on a plywood servo tray supplied already mounted on the model aircraft. Adjust the servo centered on the table and drill the 4 holes with a 2mm drill. Apply a drop of medium CA glue or epoxy for 5 minutes to each hole for better fixation and vibration resistance. We recommend 4-40 wire linkage and Dubro 4-40 Heavy Duty ball links.

Recommended deflection: between 50mm (low rate) to 80mm (high rate) for left and right (measure with ruler at end of surface).



Above: rudder horns position with one-side operation command.

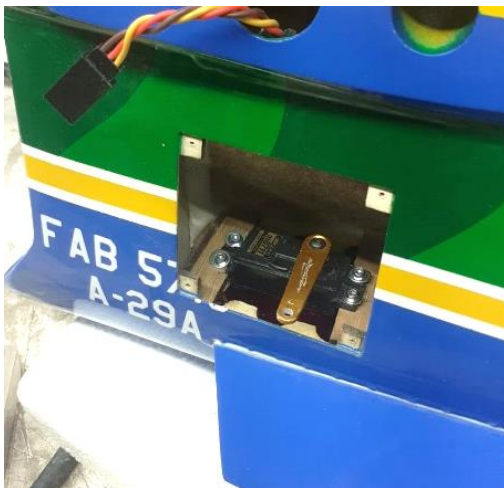

Above: rudder servo position inside the fuselage (left), servo arm linkage (center) and complete linkage with double HD horns(right).

Double horns with pull-pull steel cables. Main features: secure command with more complex and time-consuming installation. Removal of tail weight that can influence CG balance without adding extra weight to the nose. Required 4 straight horns (with command for both sides) with a total length between 30mm to 35mm. The servo arm must be double (with command to both sides) with a total length between 70mm to 80mm. Servo installed inside the fuselage, centered at the bottom (servo tray not supplied with the model airplane). Glue the servo tray centered on the bottom of the fuselage with 30 to 40 minutes epoxy glue. Adjust the servo centered on the tray and drill the 4 holes with a 2mm drill. Apply a drop of medium CA glue or epoxy for 5 minutes to each hole for better fixation and vibration resistance. Install the servo acting with "pull-pull" steel cables. We recommend using DUBRO (DUB 518). When installing the steel cables, allow them to cross inside the fuselage, with the one on the left side facing the right side of the rudder and vice versa. Recommended deflection: between 40mm (low rate) to 60mm (high rate) for left and right (measure with ruler at end of surface).



Above: pull-pull steel cables exits, with Dubro heavy duty 4-40 ball links fixed on control horns with 4-40 screws and parlock nuts on both sides of the fuselage.



Above: pull-pull steel cables exits with Dubro heavy duty 4-40 ball links fixed on control horns with 4-40 screws and parlock nuts on both sides of the fuselage and rear view.

IMPORTANT: even using parlock nuts it is necessary to apply thread locker on the screws.

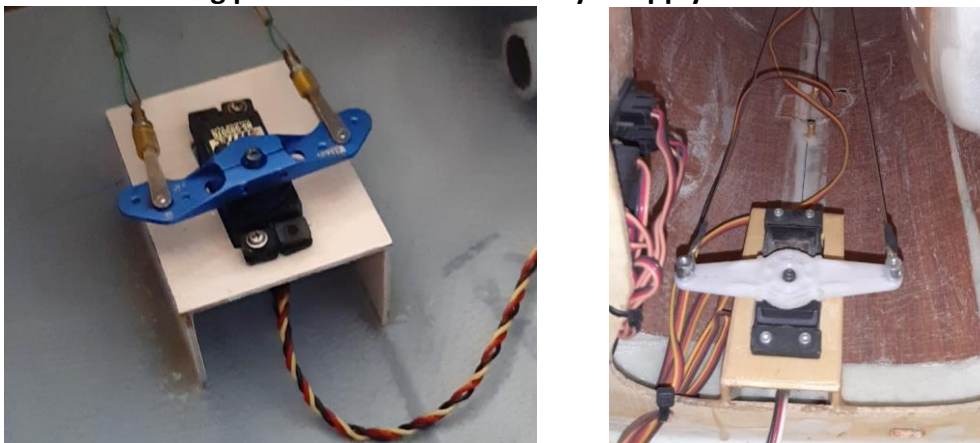

Above: the rudder servo can be installed on a plywood table glued with 30 to 40 minutes epoxy glue at the bottom of the fuselage in the case of using the pull-pull system.

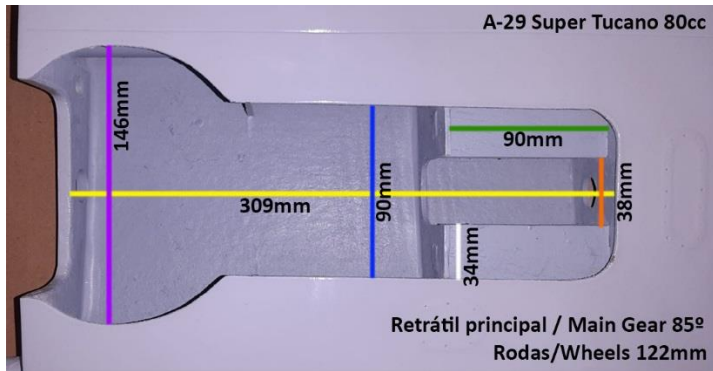
Retracts Installation: (105° on front and 85° on mains)

The A-29 Super Tucano 60TP Juniaer is prepared for easy installation of retracts, which can be pneumatic (actuated by compressed air) or electric (actuated by electric motors). The photos above show the measurements of the retracts bases and compartments. The wing retracts fixing bases are made in 10mm plywood and the front ones in epoxy resin with 10mm plywood and are solid enough to withstand the efforts required by the normal performance of the model aircraft. When defining the drilling locations for fixing the retracts to the bases, check that the wheels are centered in the compartments when retracted and that the tire alignment is parallel on the 2 sides of the wing and on the front.

If using scale-shaped main retracts, it is necessary to excavate part of the wooden fixing block to accommodate the upper part of the triangular-shaped strut when retracted as in the photos below:



Above: lowering of the main retractable block (wing) to accommodate the triangular shape of the strut.





JP Retract Set with electromagnetic brakes

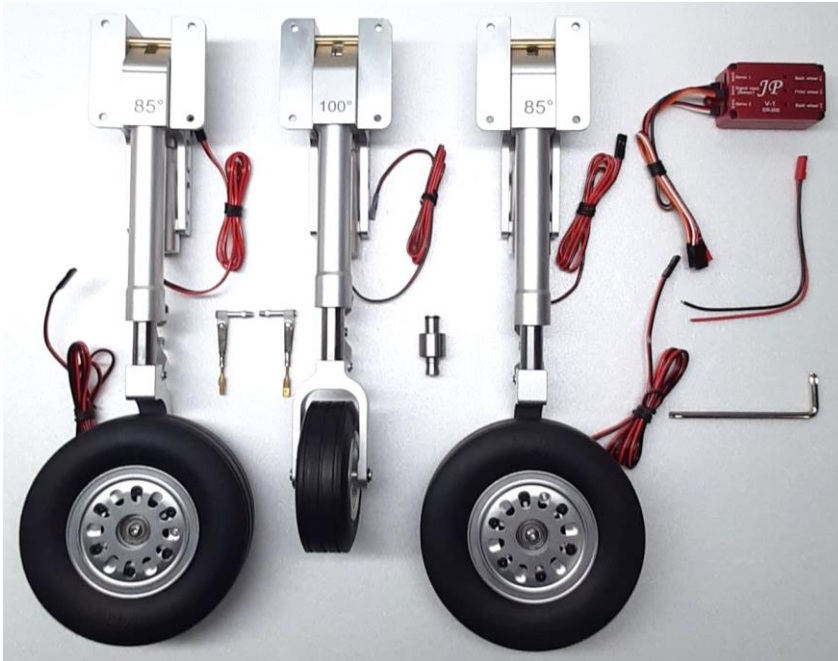

CNC machined. Aluminum cubes and bearings on wheels. 4 1/2" (114,3mm) main wheels and 75mm front wheel. Smooth acting oleo shock absorbers. Supplied with 85-degree machines on mains and 100-degree on front, no painting. Electromagnetic brakes on the 2 main wheels. Includes 2 front wheel control arms and metal pull-pull controls, 1 replacement bushing for the front landing gear and 1 allen wrench.

Struts diameter: 18mm

Mounting Struts diameter: 15mm

Wheels axle diameter: 8mm

Brakes working voltage: 7.2-30V

Controller weight: 50g

Set total weight: 2000g

JP ER-200 V-1 HV controller with door sequencer and brake actuator

Input voltage: 7.4V to 8.4V (2S LiPo)

Dimensions: 52 x 32 x 22 mm (length width height)

Plugs compability: Futaba, Jr, Graupner

The electronic controller is supplied with electromagnetic brakes controller and landing gear doors sequencer in version 1, with the same opening and closing routine necessary for the A-29 Super Tucano. It has 2 servo access doors via standard 3-way servo plugs (+ / - / signal) and 3 retracts access ports (main and front) via 2-way JST plugs (+ and -).

The controller requires a battery to power the retracts system. The manufacturer recommends using a good quality LiPo 2S 7.4V battery.

The approximate consumption of the retractable system is 200mAh per retract/extend cycle. Thus, a 2000mAh battery is capable of retracting and extending the retractable fully 10 times, approximately, under normal operating conditions.

VERY IMPORTANT: Landing gear door servos should be high voltage (7,4V). Check the proper voltage for both the controller and the servos used.

It is necessary to connect the electronic controller to a designated receiver channel to control the landing gear position (extended or retracted) via standard 3-way servo plug (+ / - / signal). The channel assigned to the retracts command must be set to 100% travel (EPA or ATV) in both positions.

Retract set operation sequence with the V-1 controller option:

- 1) Turn on radio and receiver setting EPA or ATV to 100% in both switch positions.
- 2) Plug the 7,4V 2S Li-Po battery to the controller by the JST plug.
- 3) Set the retracts switch to close retracts. The controller will retract the landing gears and then close the gear door.
- 4) Move the retracts switch to open position. The controller will open the gear door, then open the landing gears.

Full set content:

- 2x metal struts for main gear equipped with 4 1/2" wheels and brake system
- 1x metal strut for front landing front equipped with 75 mm wheel and pull-pull arms
- 2x JP Hobby ER-200 85° retracts actuators on bases (up to 25kg/low assembly/internal actuator)
- 1x JP Hobby ER-200 100° retract actuator on base (up to 25kg/ low assembly/internal actuator)
- 1 JP Hobby ER-200 V1 controller. Gear doors and brakes integrated commands



Above: JP ER-200 V1 controller with brakes showing retracts connections on upper side and brakes outputs on lower side (left photo). JST plugs (male and female) and the 2 standard 3-way servo plugs for retracts and brakes signal (center). Power wire (red and black) retracts radio signal wire (yellow, red and brown), brakes radio signal wire (red, black and white) and gear doors servos connections (right photo).

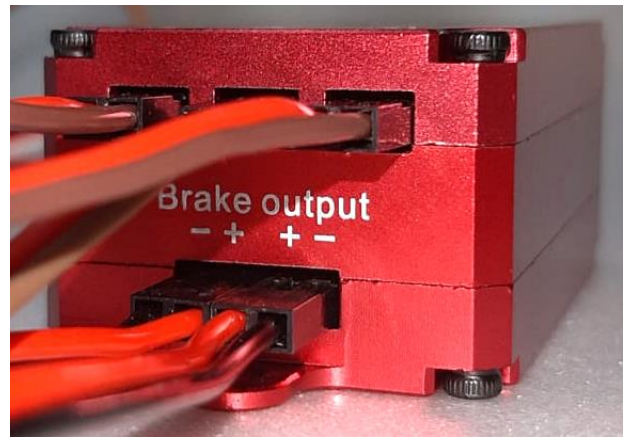
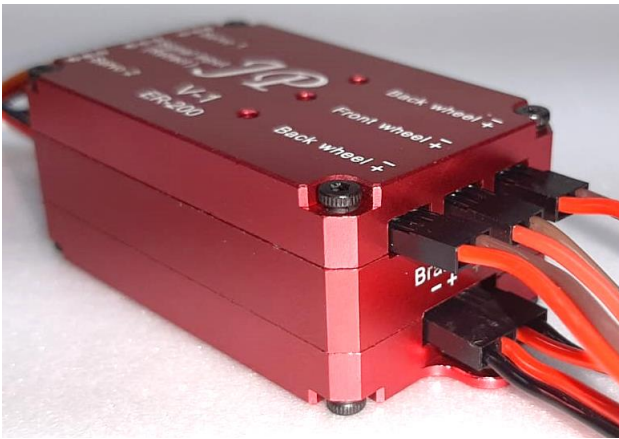

Above: JP ER-200 V1 controller with brakes showing retracts connections on upper side and brakes outputs on lower side. Note the correct polarity of wires as written at controller case.

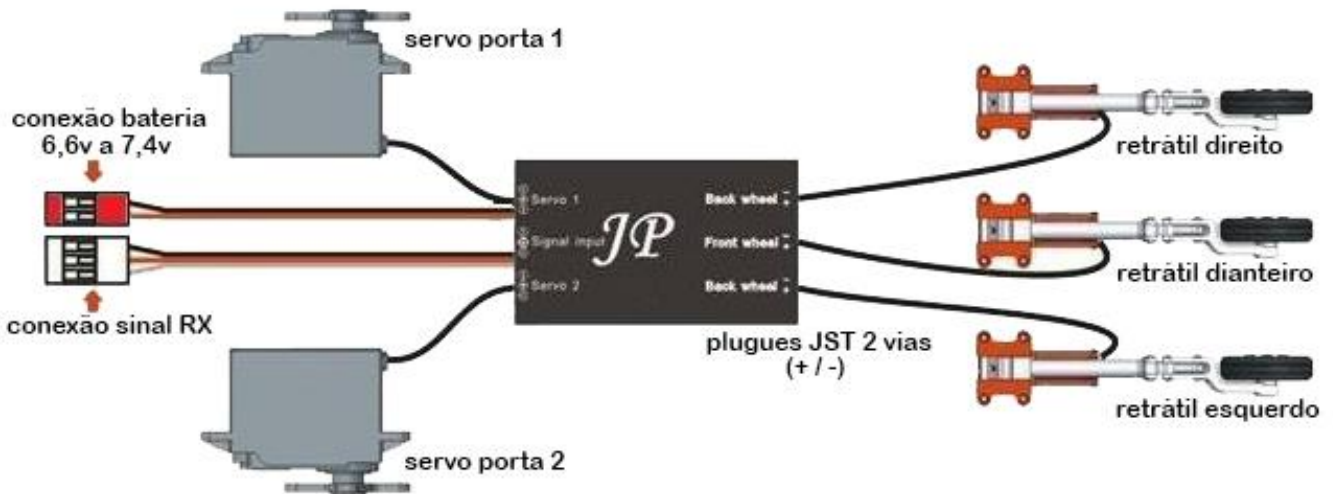

Above: Above: JP ER-200 V1 electronic controller installation diagram.

! IMPORTANT WARNINGS

BE SURE TO PLUG THE BATTERY TO THE CONTROLLER IN CORRECT POLARITY (+ RED WIRE AND – BLACK WIRE). IF POLARITY IS INVERTED THE CONTROLLER WILL BURN AND BE UNUSABLE, AND THE PRODUCT WARRANTY WILL BE LOST. USE A RELIABLE JST PLUG IN YOUR BATTERY WITH ADEQUATE FITTING WITH NO POSSIBILITY OF BEING PLUGGED INVERTED. DO NOT PLUG THE RETRACTS DIRECTLY INTO THE RECEIVER WITHOUT CONNECTION TO THE CONTROLLER, OR THE ELECTRIC MOTORS MAY BURN OUT, VOIDING THE PRODUCT WARRANTY.

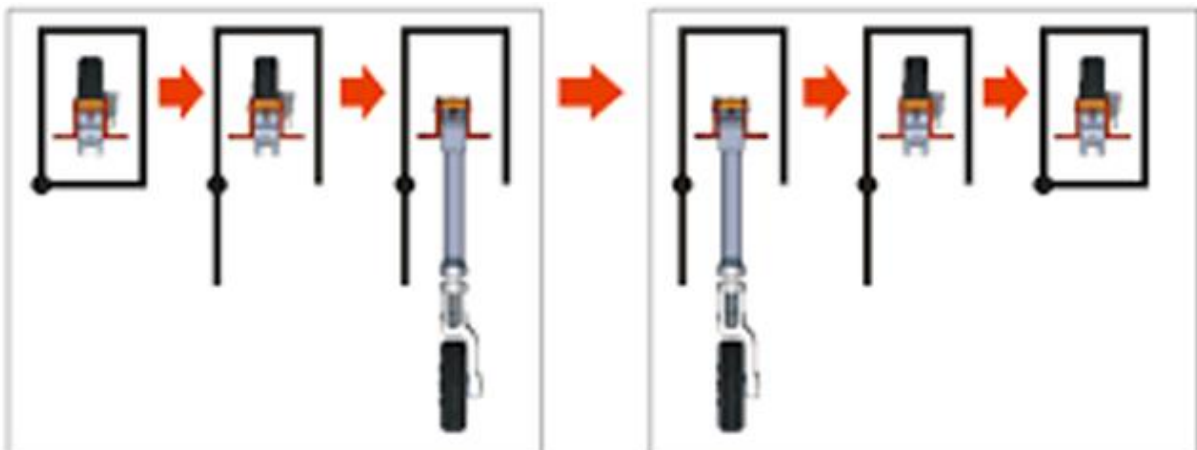

Above: retract set operation sequence diagram with the V-1 controller option.

The front wheel steering for taxi (left / right) can be done through an independent servo or with the same rudder servo. With 1 independent servo, the intensity and trembling of the front wheel control can be adjusted separately and can be turned off by mixing so as not to act when the retracts are retracted. The front wheel control servo must be attached to a centralized plywood base just behind the front landing gear compartment on the inside of the fuselage. In both cases, we recommend pull-pull linkage with steel cables and double front wheel control arm. To pass the steel cables from the inside of the fuselage to the front landing gear compartment, drill 2 small holes with a 2mm drill bit, 1 on the left side and one on the right side allowing double control without resistance or friction.



Above: front retract fixed to the turbine mount with steel pull-pull cables (left and center) and servo with pull-pull linkage for controlling the front wheel independent of the rudder servo (right).

Landing gear doors installation

The landing gear doors are supplied in unique pieces ready for installation. The landing gear doors are exposed to situations of high vibration and air displacement, so they must be installed in a very safe way to avoid risks of malfunction of the retracts and / or loss of aerodynamic performance due to drag.



Above: landing gear door set.

Main landing gear doors

The external landing gear doors must be glued to the wing with 30 to 40 minutes epoxy glue using 2 nylon hinges (we recommend DUBRO DUB 257) in each door or 2 gear doors hinges. We recommend ROBERT (ROBQ 350). Remember to check the correct alignment of the doors in the closed position to definitely glue the struts of the main landing gear with articulated supports that open and close the doors. To attach them to the external doors, glue 2 sheets of metal bent in "L" with 30 to 40 minutes epoxy glue to allow fixing with 1 screw and nut as shown in the photos below.

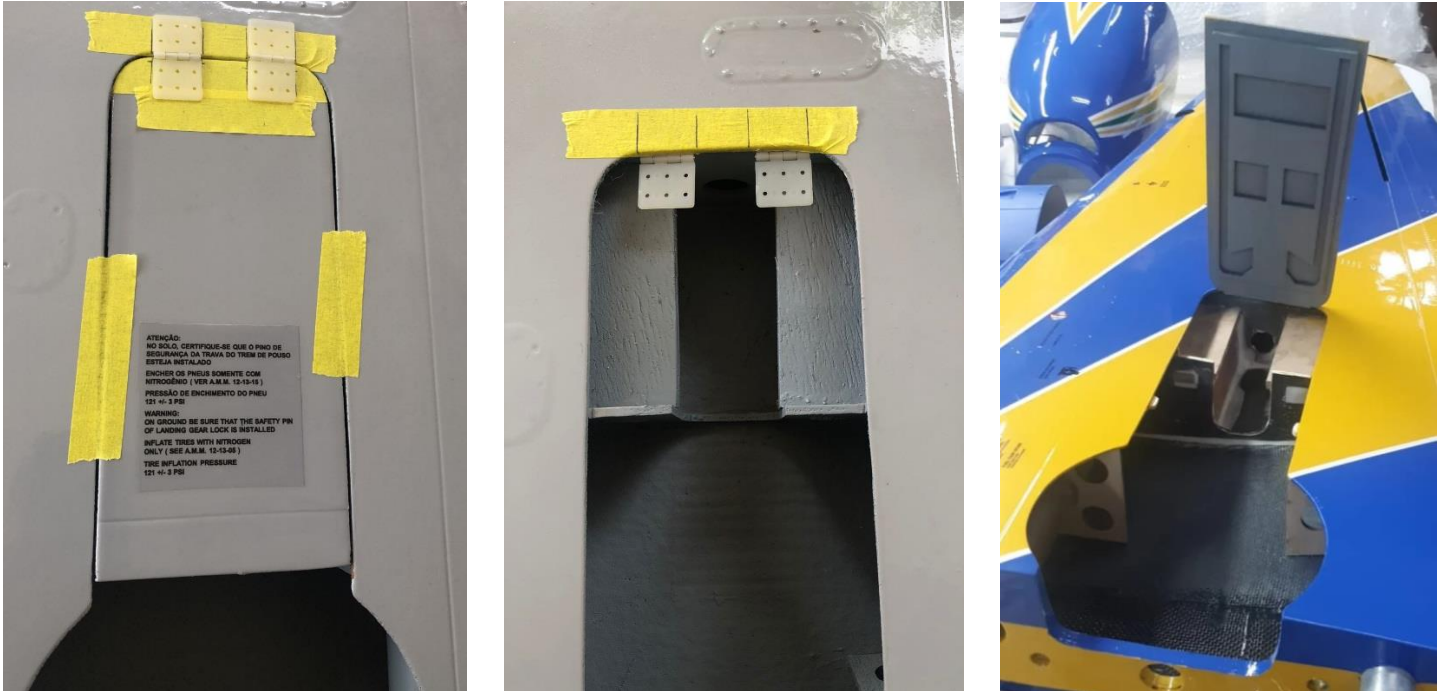

Above: external main landing gear door and hinges position on wing.



Above: external main landing gear door and hinges position on wing with landing gear door linkage.

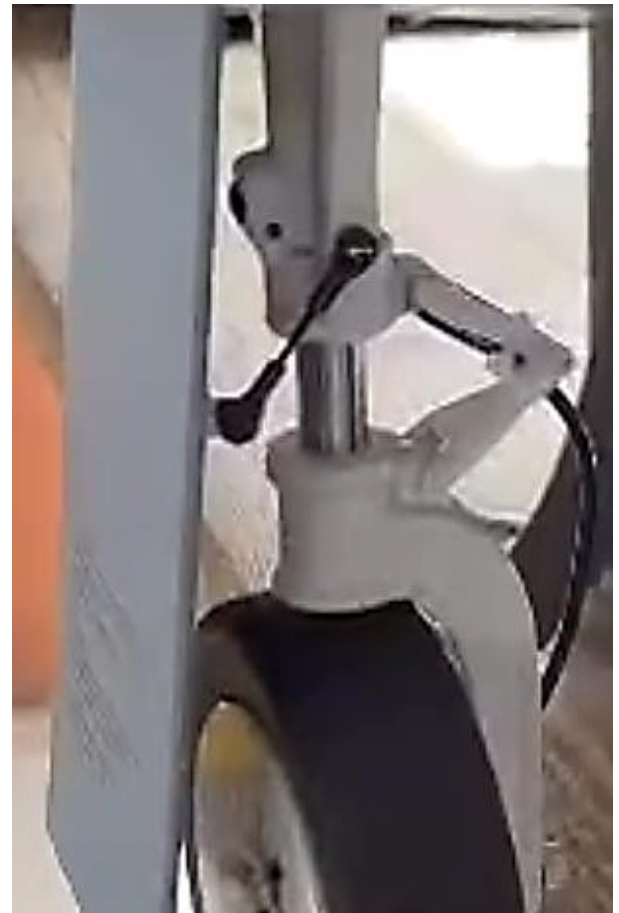

Above: right main landing gear and landing gear door connection made with a psuhrod and 2 ball links in the front part of the retract.

Front landing gear door

Cut out the central part of the lower engine cowling where the front landing gear door will be positioned. Protect the cut perimeter with masking tape so as not to damage the paintwork. Adjust the front landing gear door to fit the cut-out area of the fairing and fit the fuselage.



Above: Sequence of cutout of the lower cowling and adjustment of the front landing gear door.



Above: bonding of front landing gear door hinges with balsa wood reinforcements and servo tray for opening and closing operation.

The front door must be glued to the lower engine cowling, with 30 to 40 minutes epoxy glue using 2 compartment door hinges (supplied with the kit). Remember to check the correct alignment of the door in the closed position for definitive bonding. If desired (optional) make reinforcements around the front landing gear door closing area on the lower cowling using balsa wood as a frame.



Above: Position of installed front landing gear door and hinges.



Above: the front landing gear door installed with a Spektrum A6030 servo and 2 hinges.

The front door must be glued to the lower engine cowling, with 30 to 40 minutes epoxy glue, using 2 nylon hinges (we recommend DUBRO DUB 257) or 2 compartment door hinges. We recommend ROBERT (ROBQ 350). Remember to check the correct alignment of the door in the closed position to permanently glue.

The opening and closing mechanism of the front landing gear door can be done with 1 servo (with metal gears and with 20 Kg/cm or more of torque) or with a pneumatic piston. It is necessary to install a short horn for the linkage or use the hinge itself.

For front landing gear door opening and closing sequencing, a landing gear door sequencer or, if available, mixing via radio channels is required. The sequencing schedule should be like the routine below:

1. Landing gear and doors totally closed.
2. Front landing gear door opening.
3. 3 landing gears extension (and the 2 external main landing gears doors mechanically).
4. 3 landing gears retraction (and the 2 external main landing gears doors mechanically).
5. Front landing gear door closing.

C.G. (Center of Gravity)

The C.G. range of the model airplane is between 150 mm and 160 mm from the leading edge of the wing and the C.G. point is 155 mm from the leading edge, measured at the root of the wing.

The wing chord measures 538mm. To check the balance, hold the model in the inverted position by the wing root part at the indicated point, without fuel. Retracts must be retracted.

The model airplane must have a light nose weight tendency.

Never support the model aircraft supported only by the wing tips, always by the roots (closest to the fuselage).

Never take off your model airplane without checking that at the C.G. point the balance has a nose weight tendency because a tendency for tail weight will cause the model not to fly properly, which may cause damage and / or accidents including total loss of equipment and risks to people and property.



Notes: model airplanes with artistic painting that require greater paint overlapping and more adhesives have a greater total weight. In the case of electric motorization, it is not necessary to add weight to obtain the correct balance of the C.G., and the position of the Li-Po batteries must be defined at the end of the assembly. In the case of gas burning engines, balancing is more delicate, making it necessary to position batteries and ignition module close to the fire wall from the inside of the fuselage.

All fuselage servos and equipment in general should be positioned as far forward as possible, except for the receiver(s) which must be at least 50cm away from the ignition module to avoid noise or resonance that may cause interference, malfunction or loss of signal.

We do not recommend using large equipment trays inside the model airplane, especially at the rear of the cockpit area. It may be necessary to add extra weight to the nose of the model airplane to achieve the correct C.G. balance depending on the total weight and positioning of the equipment in front of or behind the C.G.

If necessary, add weight with lead bars until you reach the correct balance of your model as described above. Note that in the case of vertical acrobatic performance it is very important to define a very sharp nose weight tendency to allow for the recovery of flat screws, lomcevaks, stall turns and other vertical maneuvers safely.

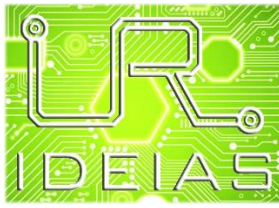

Plenus Lux

We offer (sold separately) the custom scale lighting kit for the A-29 Super Tucano 85cc Juniaer, in Plenus 5 (extra shine intensity) version.

Specifications:

Voltage: 12v Recommendations: Li-Fe 6,6V, Li-Po 2S 7,4V or Li-Po 3S 11,1V 1800 mAh to 2100mAh.

With any battery and voltage within specification, the brightness of the LEDs will be the same. Receiver independent power, system exclusive battery. Consumption current: 1400 ma with 1700ma peaks.

Activation by PWM-Pulse Width Modulation, conected to a receiver channel. All radio brands compatibility. Includes anti-interference filter.

Strobes LED: SMD-Surface Mount Device, white light 11.000K, light emission power 3W, includes 180° lens. There is 1 LED in each side of the wing.

Left navigation light LED: SMD red light, light emission power 3W, includes 180° lens.

Right navigation light LED: SMD green light, light emission power 3W, includes 180° lens.

Left and right identification printed on boards.

Wing landing lights LED: SMD, white light 11.000K, light emission power 3W. There is 1 LED in each side of the wing.



Above: wingtip boards with navigation lights and strobes (left), wing landing lights (center) and front landing gear landing lights (right).



Above: fuselage dorsal beacon (left), fuselage intercept headlight (center) and vertical stabilizer formation lights (right)

Front landing gear landing lights LEDs: 2 LEDs top 5mm, white light, 11.000K, power 3W.

Dorsal fuselage beacon LEDs: 2 5mm hat type LEDs, red light, 11.000K, power 1/2W.

Fuselage's interception headlight LED: 1 LED, White light, 11.000k, power 3W, with lens.

Vertical stabilizer formation lights LEDs: 2 LEDs, White light, 11.000K, power 1W.

It is recommended to disconnect the battery from the circuit when not using the model aircraft for more than 5 days.

It is necessary to connect the circuit to a receiver channel controlled by a 3-position switch on the radio. When the system is connected to the battery, the circuit performs a self-test by turning on all the lights for 1 second, indicating its perfect functioning. The radio control switch in the maximum position turns on the circuit, turning on all the lights (fixed and flashing), in the middle position, it turns off only the landing lights and keeps the navigation lights on and in the minimum position turns off the circuit, turning off all the lights.

Note that the boards are labeled on the right (green light) and on the left (red light). To pass the lighting kit wires inside the wing, position it with the tip up and insert a thread with a weight tied to the tip through the hole in the wing tip until it comes out through the front hole in the wing root. Tie the connector of the wing light extension to the end of the thread at the end of the wing and carefully pull the connector to the root of the wing, leaving the light board of the wing tip on the outside. With a 90° bent wire, pull the wires from the landing light board through the opening in the leading edge of the wing and pull the plate to the outside. Repeat the same process for the other half of the wing.

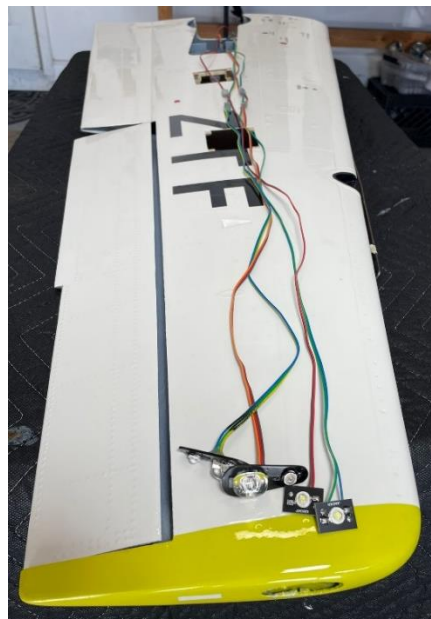

Above: weight on thread tip to pass the wires and wire to pull the wing landing light boards.

To fix the main board on the model airplane, the boards on the wing tips, landing lights and rudder board, use 3M high-adhesion double-sided tape (red). Before gluing the tapes, apply 3M 8250 adhesion promoting primer to the contact surfaces for a good result.



Above: locais corretos de fixação das placas de luz de ponta de asa (left) e faróis (right).

The clear parts for navigation lights and wing landing lights are supplied in a thermoformed set. Cut out the parts of the set with very sharp scissors and then remove the back and sides following the embossed reference line. With a 280 to 320 fine grit sandpaper, finish the cut parts, sand the inner ends of the clear parts without excess and in the places of the wing where the parts will be glued for better adhesion. Note that there are 2 right parts and 2 left parts. To glue after installing the light kit, use white canopy glue and attach the clear parts with good adhesion masking tape, allowing to cure for 12 hours. After curing, remove the tapes and clean any tape or glue residue. We recommend ZAP Formula 560 (PT-56). Never use CC glue to glue these parts, as the evaporated gases stain and damage the clear plastic material.



Above: parts cut from set.



Above: desired parts shape.



Above: clear plastic part glued at correct place.

To install the 2 red LEDs board of the beacon on the fuselage back, it is necessary to remove the 2 replicas of the LEDs and make 2 holes with a 5mm drill. Insert the board from the inside of the fuselage and test the accommodation of the LEDs. Apply 5 to 10 minutes epoxy glue in the contact area of the board with the fuselage and place it in the final position until the glue has completely cured. The 2 red LEDs must be exposed on the outside of the fuselage.



Above: position of the LED replicas on the fuselage back that must be cut and drilled with a 5mm drill.



Above: definitive position of the red LEDs on the back of the fuselage after internal fixing of the board.

To install the vertical stabilizer formation lights, precise cuts must be made in the places where they will be fixed. To pass the boards to their installation locations, use a line to pull from the inside of the fuselage. Test and check until they are well positioned and glue them with epoxy glue for 5 to 10 minutes.



Above: right side of the original vertical stabilizer without cuts (left), cuts on the left side of the vertical stabilizer to allow the installation of formation lights (center) and LEDs properly installed (right).

To install the intercept headlight on the right side of the fuselage, a 20mm hole must be drilled in the front part of the fuselage, where there is a marking to accommodate the headlight. Test and check until it is well positioned and glue it with 5 to 10 minutes epoxy glue.



Above: position of the intercept headlight on the front right side of the fuselage.

Fuselage on-board equipment

The A-29 Super Tucano 85cc Juniaer has plenty of internal space to accommodate on-board equipment such as receiver, retractable controller, light controller, landing gear door sequencer, among others. We do not recommend the installation of very large or heavy trays at the rear of the fuselage for correct C.G. balance. Below are some examples of assemblies and installations of this equipment. Always remember to fix all components very well and lock all splices and servo connections and equipment extensions as they will be subjected to high levels of vibration due to the operation of the gas burning engine. Test the functioning of all components of your model aircraft before flying.

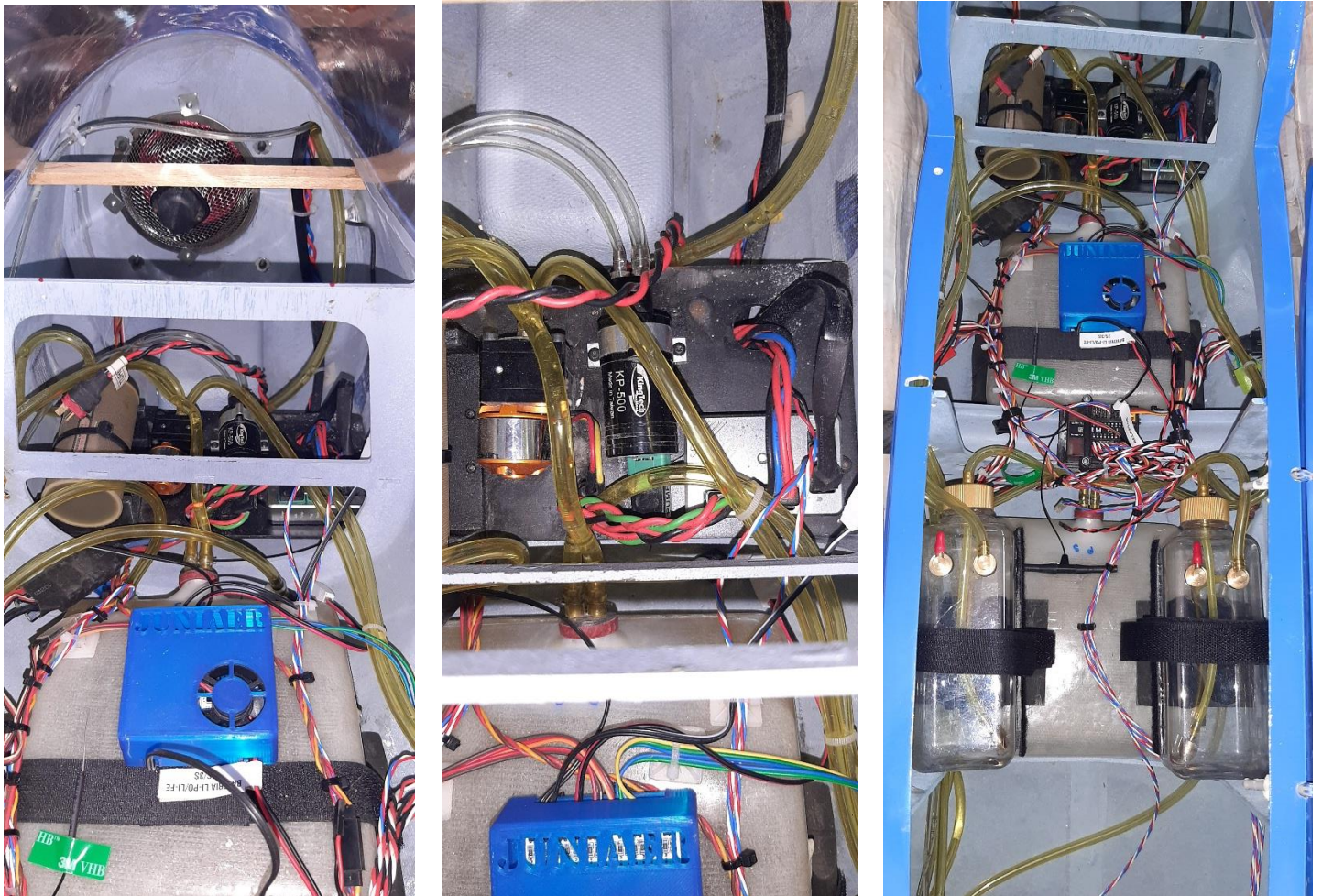

Above: example of installation of turbine components, lights controller, fuel and smoke fluid tanks.

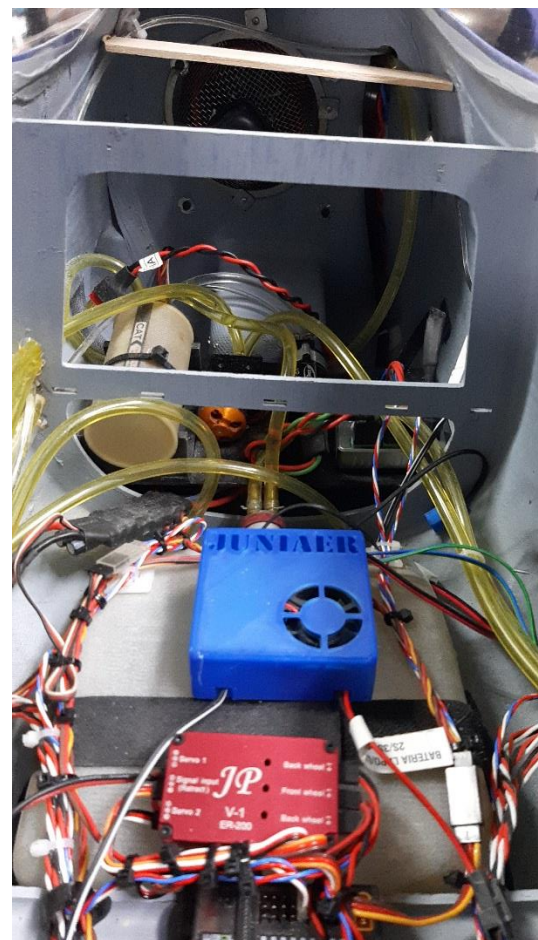
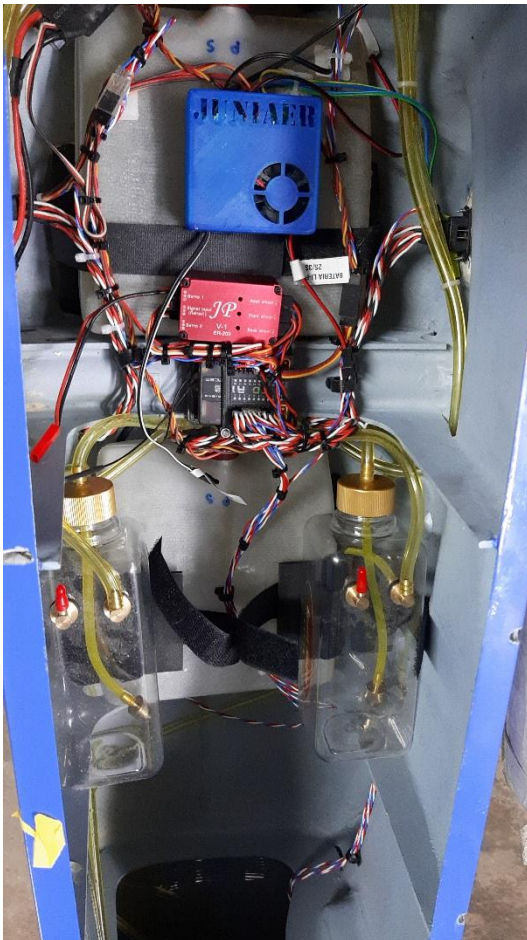

Above: example of installation of turbine components, lights central, retracts controller, receiver and fuel and smoke fluid tanks.

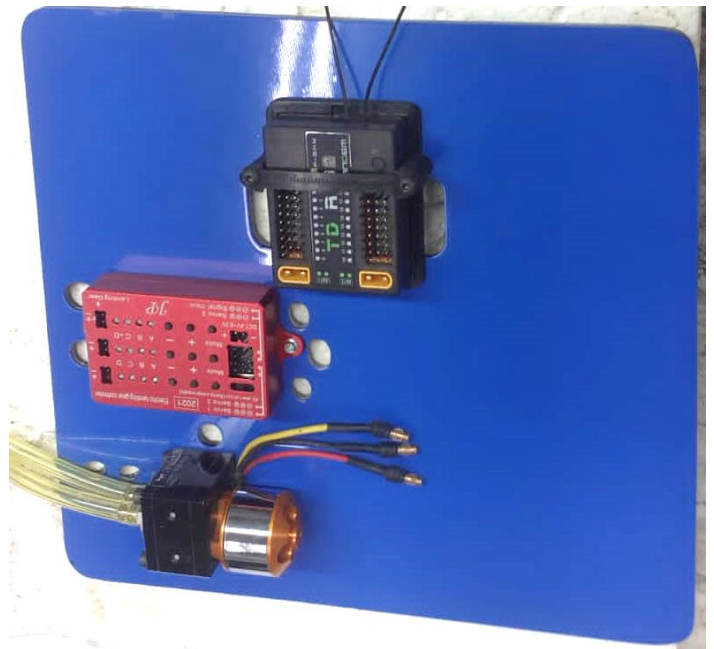
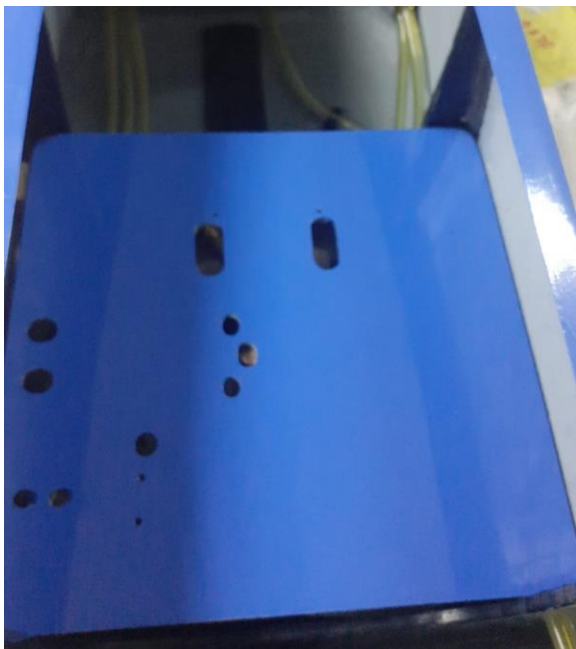

Above: equipment and accessories tray example.

Control Surfaces Recommended Deflections:

Ailerons: Between 18mm (25/32") (low rate) to 25mm (1") (high rate) – up and down

Elevators: Between 27mm (5/8") (low rate) to 35mm (25/32") (high rate) – up and down

Rudder: Between 40mm (1 5/8") (low rate) to 50mm (2") (high rate) – left and right

Flaps: Between 0° to 10° for take off and between 25° to 30° for landing

Fuselage side doors



Above: right side door (bigger, on left), left side door (smaller, on center) and hinges and latches supplied with the kit for side doors installation (right).

Your A-29 Super Tucano 60TP Juniaer has two side doors where the luggage compartment is on the aircraft. The doors must be installed according to the photos below with the door hinges and latches supplied with the kit to be glued with 30 to 40 minutes epoxy glue. Inside there is enough space to easily install on / off switches, air supply, pressure gauges, tachometer, access to charge batteries, voltage monitors, etc.

Secure the door to the outside of the fuselage in correct alignment on all sides with masking tape. With a sharp knife, make room for the hinge to pass through and glue it to the inside of the fuselage with 30 to 40 minutes epoxy glue on the fuselage and doors. Wait for the glue to cure completely, remove the tapes and check the opening and closing of the doors. Make room for the door lock actuators with a sharp knife as well as a hole in the bottom of the door for the wire to lock when closed. Stick the lock with 30 to 40 minutes epoxy glue and wait for the glue to fully cure.



Above: door with installed hinges and latch seen by the inside (left) and outside (right).



Above: door with installed hinges and latch in closed position (left) and open (right).

If you want to install only 1 of the doors, the other must be fixed and glued to the fuselage with 30 to 40 minutes epoxy glue and remain in the final position. Sand the contact areas of the door and fuselage with 100 to 150 grit sandpaper, apply 30 to 40 minutes epoxy glue and secure the door in the correct position with masking tape until the glue cures completely. Another option is to screw the door on 2 wooden blocks to be glued with 30 to 40 minutes epoxy glue inside the compartment.



Above: wooden blocks glued in internal part of compartment (left), door in correct place (center) and screws for fixing the door to the fuselage (right).



Above: internal compartment of fuselage side door installed accessories examples.

Fuselage and vertical stabilizer fins gluing

The 2 fins at the rear of the fuselage and the 2 fins on the vertical stabilizer must be glued in their final positions. Sand the areas to be glued to the fins and friezes on the fuselage with 100 to 150 grit sandpaper, apply 30 to 40 minutes epoxy glue and secure in the correct position with masking tape until the glue cures completely. Note that there must be symmetry between the angles of the fins when viewed from behind the fuselage, with the fuselage ones being 45 degrees downwards in relation to the ground line, while the vertical stabilizer ones are horizontal. Even the angles on both sides before the glue has fully cured. Use the photos below as a reference.

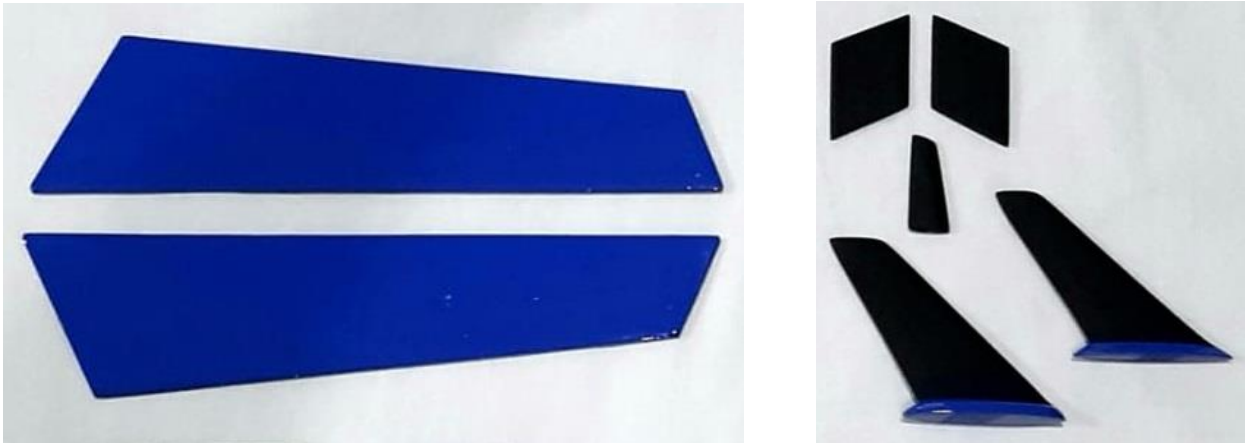

Above: the two fuselage fins must be glued together with the widest part facing forward (left). The three fuselage antennas, the largest being the lower one, and vertical stabilizer fins (right)

Antennas gluing

The 2 antennas at the top of the fuselage (1 large and 1 small) and the antenna at the bottom of the fuselage (larger) must be glued in their final positions or installed with magnets so that they are easily and practically removable. To glue, sand the areas to be glued on the antennas and on the fuselage bases with 100 to 150 grit sandpaper, apply 30 to 40 minutes epoxy glue and secure in the correct position with masking tape until the glue is completely cured. Use the photos below as a reference.



Above: A-29 Super Tucano 80cc Juniaer profile showing antennas and fins positions.

A good option if you want to install the 3 removable fuselage antennas in a very simple and practical way is to use metal pins and magnets to easily insert and remove:



Above: fuselage top antenna installation with magnet and 2-pin.



Above: fuselage low antenna installation with magnet and 2-pin.

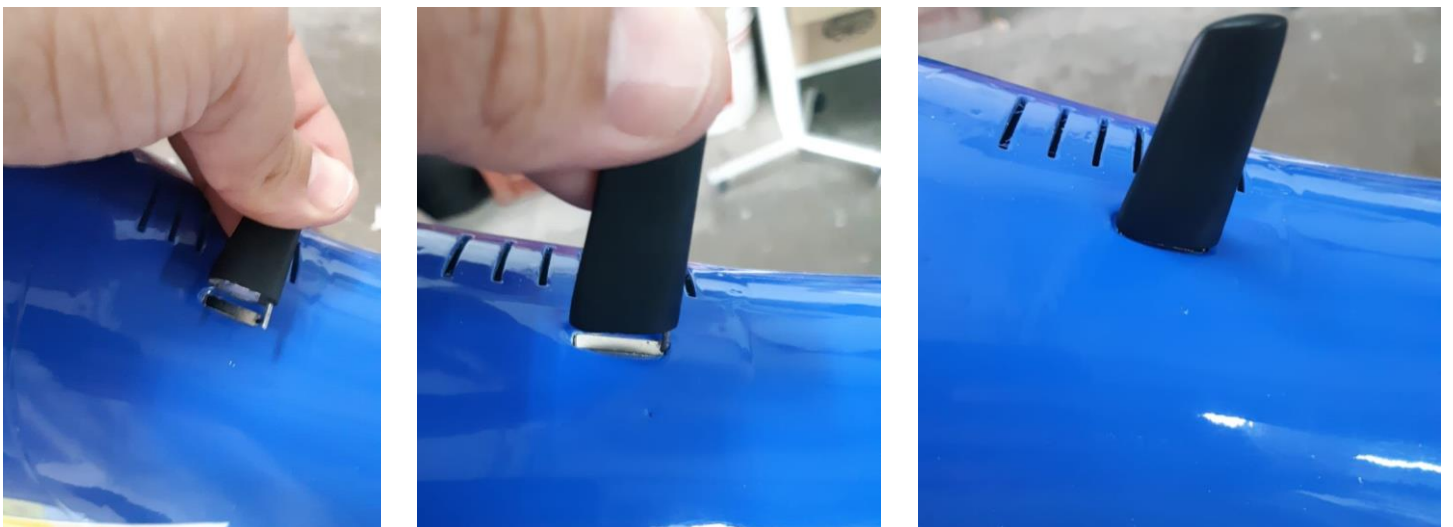

Above: fuselage small top antenna installation with magnet and 2-pin.

Machine guns replicas installation (optional)

We offer (sold separately) replicas of the 2 FN M-3P machine guns caliber.50 BMG (12.7 mm) with a removable fastening system for ease of transport. Made in 3D printing, painted and to the correct scale for your A-29 Super Tucano 85cc Juniaer.

To install the replicas it is necessary to drill a hole in the 2 circular markings of the two halves of the wing on the leading edge, gluing the back of the replicas to the wing with 5 to 10 minutes epoxy glue in the correct alignment. The front part of the replicas can be removed simply by unscrewing it from the back part glued to the wing.

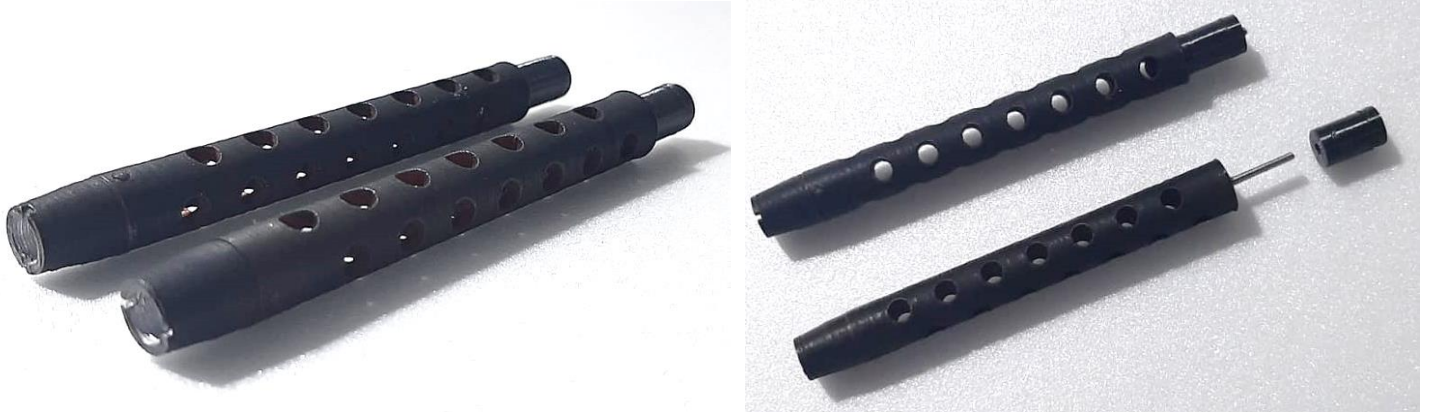

Above: machine gun replicas (left) and removable fastening system (right).



Above: hole opening for installing the machine gun replica close to the leading edge of the wing.



Above: machine gun replica position on wing after installation.

Cockpit and canopy installation

The stock cockpit fits perfectly in the fuselage and is removable. It is not necessary to glue or attach to the fuselage. The canopy frame will keep it in the correct position.

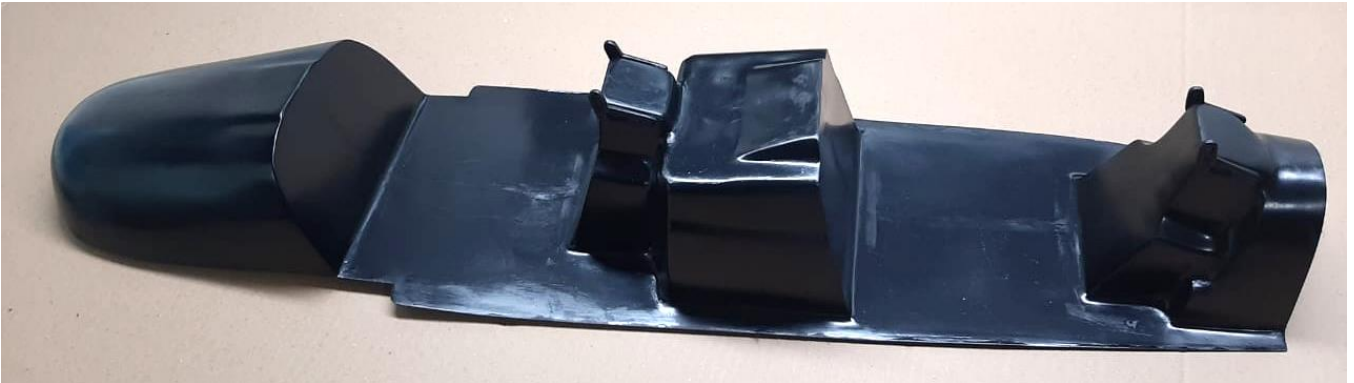

Above: stock cockpit.

To fix the instruments panels adhesives, use the drawings below as reference:



Above: front panel (left) and rear panel (right) A-29 Super Tucano.



Above: stock simple cockpit fitted to the fuselage with canopy frame.



We offer (sold separately) customized cockpits for your A-29 Super Tucano 85cc Juniaer, extremely detailed and realistic, ready to install as a replacement for the stock cockpit. Supplied in 2 versions: Complete cockpit for competition scale single-seater with rear tank or two-seat version, with complete lower part, for full body pilots.



Above: detailed scale cockpit with front seat, instruments, stick, throttles and HUD.



Above: details of the instruments, lever, stick, side panels and seat.



Front set		
1	Front canopy frame with mirrors	13g
2	Left side canopy	34g
3	Right side canopy	38g
4	Frontal console	61g
5	HUD	39g
6	Front cockpit with seat and panels	532g
Front set total weight: 717g		
Rear set (extra fuel tank)		
7	Rear canopy frame	9g
8	Rear left canopy frame	6g
9	Rear right canopy frame	6g
10	Extra fuel tank replica	319g
11	Rear canopy frame	17g
Rear set total weight: 357g		
Full set total weight: 1074g		

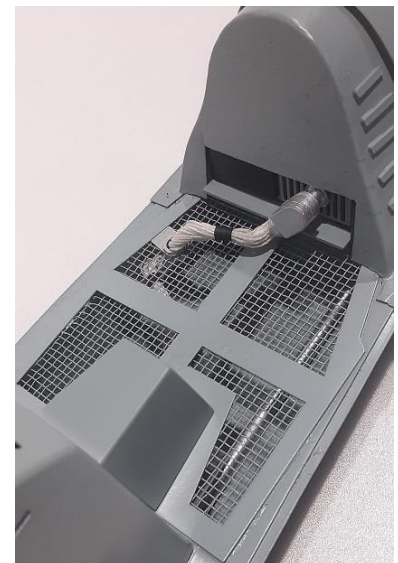

Above: detail of the right side of the canopy (left) and the rear of the extra tank (right).

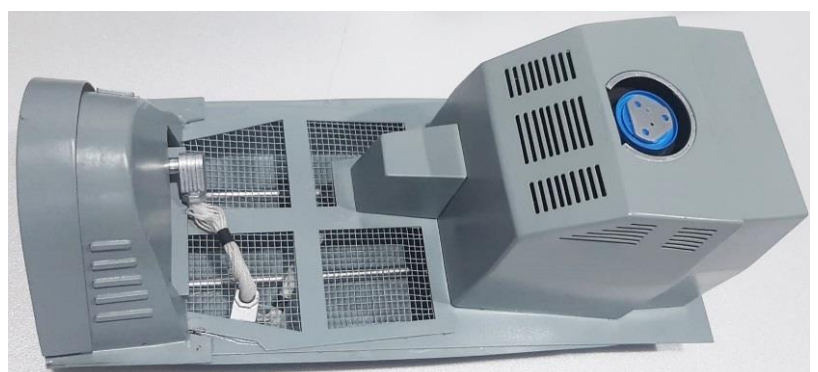

Above: fuel tank cover (left) and rear cockpit (fuel tank replica) overview (right).

Full body scale pilots in uniform

We provide (sold separately) custom-made pilots for your A-29 Super Tucano 60TP Juniaer using the scale cockpit, with sewn uniforms, articulation of legs, arms and head and helmets with movable visor painted according to the painting of the model aircraft for greater realism. Weight:185g.



Programmable robot pilots with arm and head movement

Miami Animatronics



by Ralph & Andrea Esposito

Miami Animatronics pilots are the definitive option for those who want to add maximum realism to their model airplane. They are programmable robot pilots to make a sequence of head and arm movements. A perfect match with Flávio's competition scale cockpit.

The kits are sold separately directly in the United States of America by Miami Animatronics with the option of only the electronic kit with actuator mechanisms or the pilots complete and ready through the e-mail contact: ups767captain@hotmail.com

The site contains videos and links to detailed instruction manuals. Access to know the most advanced replicas of pilots for model airplanes, including the option of personalizing faces: <https://www.miamianimatronics.com>



Above: incredible realism of the robot pilots' uniforms, boots, gloves, helmets and equipment (left) and kit with electronics and actuators to make programmable movements (right).

To make the canopy/frame assembly with side opening, use the 2 hinges (supplied with the kit). The opening is from left to right, so the hinges must be fixed on the right side of the fuselage.

The fastening locations of the hinges on the canopy frame must be on the same line to allow opening and closing without friction or deformation. The recommended distance from the rear part of the canopy to the rear hinge is 19.5cm and to the front hinge 33.5cm (see photos below).

Make an opening and closing simulation before finally fixing the hinges. Make recesses in the fuselage flap to allow full movement of the hinges when opening and closing the canopy. It is very important that the hinges are very well attached to both parts. Apply epoxy 30 to 40 minutes. After the glue cures completely, apply more epoxy glue to the inside of the fuselage again to reinforce the structure.

Cut the end part of the hinges for a better finishing.

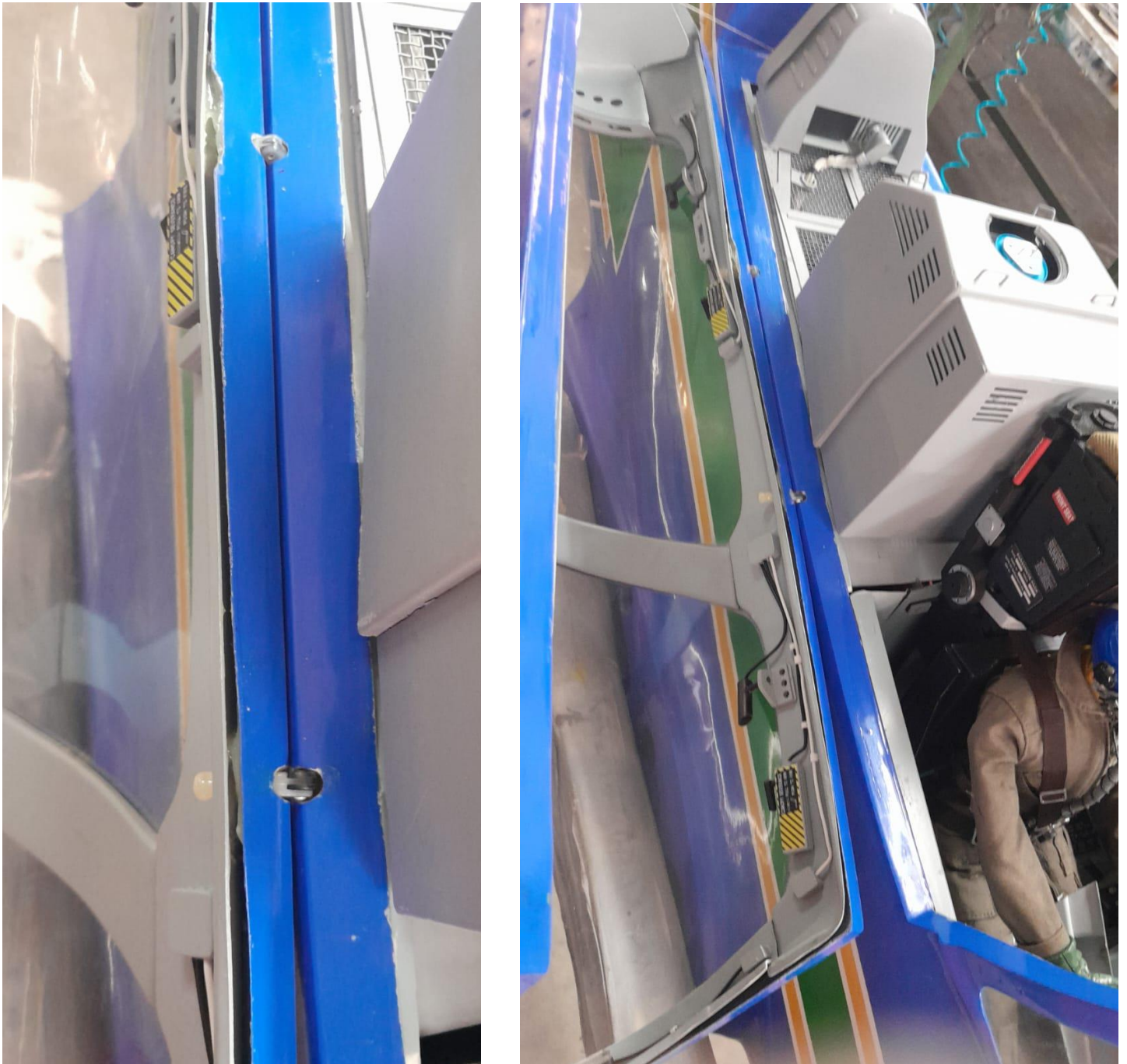

Above: position of the 2 canopy side opening hinges already installed with the scale cockpit.

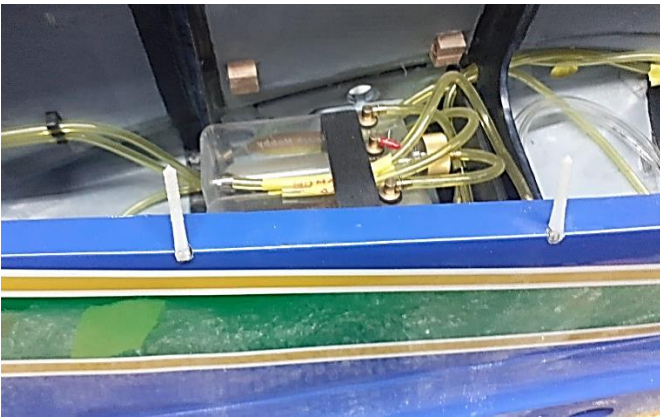

Above: canopy assembly hinges on fuselage (left) and in position for gluing to fuselage and canopy frame (right).



Above: The recommended distance from the rear of the canopy to the rear hinge is 19.5 cm and to the front hinge 33.5 cm.



Above: details of the gluing of a canopy hinge inside the fuselage, through the scale cockpit (left) and the 2 installed hinges seen from the outside of the fuselage (right).

To lock the canopy / frame assembly in the closed position on the fuselage, use a piece of horn or servo arm with a hole to be fixed on the canopy frame and a spring-loaded lock as shown in the photos below. You can take advantage of the location of the replica of the canopy opening lever (see photos below). Make a slot to allow the lever to pass outside the fuselage and fix the lock on the inside with 30 to 40 minutes epoxy glue, considering the position of the horn or servo arm so that the closing is very tight and secure.

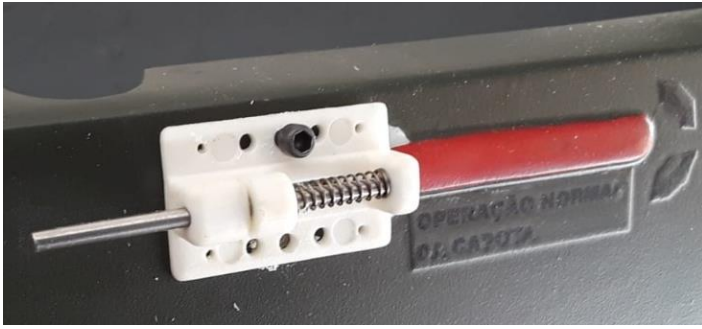

Above: lock position of the canopy / frame assembly on the fuselage.



Above: locking the canopy assembly / canopy frame inside the fuselage.

An option to make a closing and opening system for the canopy set is through a pushrod mechanism, a servo arm in a circle, springs and a lever to rotate outside the fuselage, locking or unlocking. By turning an external lever on the fuselage, the 2 latches (front and rear) lock or unlock the assembly for safe opening and closing.

The photos below show this system in detail:



Above: opening and closing system for the canopy set with latches on the front and back.



Above: opening and closing system for the canopy set with latches on the front and back.



Above: opening and closing system for the canopy set with latches on the front and back in 3 views before installation on cockpit frame.



Above: opening and closing system for the canopy set (rear part).



Above: opening and closing system for the canopy set (rear part).



Above: opening and closing system for the canopy set (front part).



Above: opening and closing system for the canopy set (front part) with front latch.



Above: external latch for opening and closing the canopy set.



Above: external latch for opening and closing the canopy set.

The clear canopy is supplied in a thermoformed single piece. Cut the canopy into the correct shape with very sharp scissors, remove the back and front parts following the embossed reference line. Cut out the front and back, separating the 2 parts.

The front part must be glued from below to the fuselage frame. The back must be glued from below to the separate frame. With a fine sandpaper 280 to 320, make the finish. Lightly sand the canopy and canopy frame contact points where the canopy will be glued for better adhesion. To glue, use white canopy glue and secure the canopy/canopy frame assembly to the fuselage with good adhesion masking tape, letting it cure for 12 hours.

After curing, remove the tapes and clean possible masking tape or glue residue. We recommend ZAP Formula 560 (PT-56). 5-to-10-minute epoxy glue can also be used for bonding.

Never use CA glue to glue these pieces together, as the evaporated gases will stain and damage the clear material.

For greater transparency, removing small scratches and handling marks from the canopy, use high gloss automotive wax.



Above: canopy as from factory.



Above: correct desired shape of the 2 canopy parts after cut.



Above: canopy frame that shall be glued from above to the rear part of the canopy.



Above: rear part of the clear canopy and canopy frame gluing.



Above: rear part of the clear canopy and canopy frame gluing and curing fixed to the fuselage to get the correct shape.



Above: front part of the clear canopy glying to the fuselage.



Above: front clear canopy glued to the fuselage and rear canopy glued to the canopy frame with side opening.

Pitot tubes replicas

The two pitot tubes replicas must be glued with 5 minutes epoxy glue to the bottom of the wing at the locations outlined with the shape of the base, 1 on the right and 1 on the left, with the tip of the tube facing forward.



A-29 Super Tucano 60TP transport and protection covers

We provide (sold separately) protective and transport covers made of durable padded material. Wing covers with zippers and handles, with wing tube housing. Stabilizer covers with zipper and fuselage cover with velcro. Custom-made for your A-29 Super Tucano 60TP.



The #2 A-29 Super Tucano 60TP prototype was taken to the AFA (Air Force Academy) in Pirassununga-SP-Brazil, the honorable Ninho das Águias (Eagle's nest), where the EDA (Air Demonstration Squadron) of the FAB (Brazilian Air Force) is based, the world famous Esquadrilha da Fumaça (Smoke Squad) on Domingo Aéreo 2022 to prove the fidelity in scale of this innovative unique and exclusive project conceived by Juniaer.



A-29 Super Tucano 60TP flew by Captain Ralph Esposito won the best cockpit interior trophy in Florida Jets 2023, at Lakeland, Florida, USA.



www.juniaer.com.br



2023



Award winner



Captain Ralph Esposito



A-29 SUPER TUCANO 60TP



A-29 Super Tucano 60TP flew by Captain Ralph Esposito was third place on Unlimited category at Top Gun 2023, Lakeland, Florida, United States.

JUNIAER
Arte em Aeromodelos

www.juniaer.com.br

INVITATIONAL TOURNAMENT
TOP GUN
1
Competitor
2023

PP-ZTF

PP-ZTF

Vaught

3rd place
Unlimited Class

Ralph Esposito

Vaught

A-29 Super Tucano 60TP flew by Diego Souza won the best scale aircraft award on Warbirds Over the Glades 2023 at Del Rey Beach, Florida, United States.



www.juniaer.com.br

A-29 Super Tucano 60TP
Diego Souza
Melhor aeromodelo escala
Best scale aircraft



A-29 Super Tucano 60TP flew by Gustavo Alonso won the best scale model airplane trophy in FESBRAER 2024, a major evento at Gaspar, SC, Brazil.



JUNIAER
Arte em Aeromodelos

370
FESBRAER
FESTIVAL BRASILEIRO DE AEROMODELISMO

www.juniaer.com.br

Melhor aeromodelo escala
Best scale model airplane

A-29 Super Tucano 60TP
Gustavo "Gugu" Alonso

Juniaer was an official sponsor in 2023 of EDA (Air Demonstration Squadron) of the FAB (Brazilian Air Force), the world famous Esquadilha da Fumaça (Smoke Squad)



Juniaer was present as an official sponsor at the celebrations of 71 years and 4000 demonstrations of the EDA (Air Demonstration Squadron) of the FAB (Brazilian Air Force), the world famous Esquadrilha da Fumaça Smoke Squadron, on May 13, 2023



<https://www.juniaer.com.br/>

e-mail: juniaer@hotmail.com

www.facebook.com/asaseses.juniaer

Telefones: (35) 9149-8548 (Whatsapp) Elton

www.instagram.com/juniaermodelismo/

(35) 3591-1036 (fixo)

twitter.com/Juniaer

[You Tube - JUNIAER](https://www.youtube.com/channel/UCJUNIAER)